

### **Copyright Information**

Copyright © 2021 by SHENZHEN SMARTSAFE TECH CO.,LTD. All rights reserved. No part of this publication may be reproduced, stored in a retrieval system, or transmitted in any form or by any means, electronic, mechanical, photocopying, recording or otherwise, without the prior written permission of SMARTSAFE.

Neither SMARTSAFE nor its affiliates shall be liable to the purchaser of this unit or third parties for damages, losses, costs, or expenses incurred by purchaser or third parties as a result of: Accident, misuse, or abuse of this unit, or unauthorized modifications, repairs, or alterations to this unit, or failure to strictly comply with SMARTSAFE operating and maintenance instructions. SMARTSAFE shall not be liable for any damages or problems arising from the use of any options or any consumable products other than those designated as Original SMARTSAFE Products or SMARTSAFE Approved Products by SMARTSAFE.

All information, specifications and illustrations in this manual are based on the latest information available at the time of printing. SMARTSAFE reserves the right to make changes at any time without prior written or oral notice.

### **Trademark Information**

**SmartSafe** is a registered trademark of SHENZHEN SMARTSAFE TECH CO.,LTD. in China and other countries. All other SMARTSAFE trademarks, service marks, domain names, logos, and company names referred to in this manual are either trademarks, registered trademarks, service marks, domain names, logos, company names of SMARTSAFE or are otherwise the property of SMARTSAFE or its affiliates. In countries where any of the SMARTSAFE trademarks, service marks, domain names, logos and company names are not registered, SMARTSAFE claims other rights associated with unregistered trademarks, service marks, domain names, logos, and company names. Other products or company names referred to in this manual may be trademarks of their respective owners. You may not use any trademark, service mark, domain name, logo, or company name of SMARTSAFE or any third party without permission from the owner of the applicable trademark, service mark, domain name, logo, or company name. You may contact SMARTSAFE by visiting the website at [www.news-smart-safe.com](http://www.news-smart-safe.com), or writing to SHENZHEN SMARTSAFE TECH CO.,LTD., 3310, Building 11, Tianan Cloud Park, Bantian Street, Longgang District, Shenzhen, Guangdong, China, to request written permission to use Materials on this manual for purposes or for all other questions relating to this manual.

## Contents

<b>1. Product Overview .....</b>	<b>1</b>
1.1 Product Features .....	1
1.2 Main Function and Test Range .....	1
1.3 System Components .....	1
1.4 Working Conditions .....	1
1.5 Environment & Energy Impact .....	1
1.6 Protection & Alarm .....	2
<b>2. Precautions for Safe Use .....</b>	<b>2</b>
2.1 Safe Working Period & Production Date .....	2
2.2 General Rule .....	2
2.3 Common Incorrect Operation .....	2
2.4 Damage Probably Caused By Incorrect Operation .....	2
2.5 Emergency Treatment In Exceptional Cases .....	2
2.6 Precautions In Exceptional Circumstances .....	2
2.7 Other Safety Alerts .....	2
<b>3. Technical Features .....</b>	<b>3</b>
<b>4. Operating Instructions .....</b>	<b>4</b>
4.1 Panel Description .....	4
4.2 Interface Pin Definition .....	4
4.3 Main Unit Connection .....	5
4.4 Main Unit Operation .....	8
4.5 Discharge & Charge .....	8
4.6 Equalization .....	13
4.7 System Settings .....	20
<b>5. Fault Analysis and Troubleshooting .....</b>	<b>24</b>
<b>6. Transport &amp; Storage .....</b>	<b>24</b>
<b>7. Environmental Protection and Others .....</b>	<b>24</b>
<b>Warranty .....</b>	<b>25</b>

## 1. Product Overview

iSmartEV ED500 battery maintenance tester integrates battery string discharge-charge and cell equalization functions into one unit. It is applicable in battery discharge-charge test and multi-channel cell equalization test.

### 1.1 Product Features

- Adopt the latest equalizing maintenance technology and avoid the interference to BMS (Battery Management System), iSmartEV ED500 is designed for lithium battery pack daily discharge, charge, and equalizing maintenance.
- Based on wide voltage range design, iSmartEV ED500 can be applied to lithium battery packs testing with various voltage levels.
- Equalizing maintenance test mode can activate the lithium battery performance completely.
- Voltage and temperature monitoring and protection during test can prevent over-charge and over-discharge.
- Multiple discharge auto-stop conditions make testing mode more intelligent and flexible, and avoid over-charge and over-discharge.
- Intelligent equalizing function based on each cell voltage monitoring and equalizing charge.
- Support equalizing maintenance parameter customization.
- Support multiple protection design and alarm settings of voltage, current, temperature abnormal to protect the battery and the tester.
- Support functions such as overvoltage, undervoltage, overcurrent, output short circuit, anti-reverse protection and overheating protection.
- Adopt wave width modulation technology, high efficiency, high power factor, low noise, low electromagnetic interference.
- 7-inch touch screen, easy to operate.
- Built in memory, supporting automatic storage of operation records.
- Portable design, easy to carry and transport.

### 1.2 Main Function and Test Range

Mainly used for lithium battery pack charge & discharge test and equalizing maintenance, suitable for various voltage levels.

### 1.3 System Components

The device consists of main unit, test cables, cell voltage acquisition kit (CAN communication kit/physical sampling kit), AC power cord. Please check the actual configuration subject to the packing list.

The main unit is organized by LCD touch screen, data processing unit, data acquisition unit, auxiliary power unit, discharge unit, charge unit, equalization unit, and panel operating unit.

### 1.4 Working Conditions

NO CORROSIVE, NO EXPLOSIVE, NO ELECTRICAL BREAKDOWN AIR OR CONDUCTIVE DUST.

### 1.5 Environment & Energy Impact

The tester can convert the tested battery energy into heat and use cooling system to blow the heat

out of the unit, so during the discharge test, please pay more attention to heat dissipation and ventilation.

## 1.6 Protection & Alarm

This tester has hardware and software protection functions such as reverse connection, overvoltage, overcurrent, overtemperature, communication error, etc.

## 2. Precautions for Safe Use

### 2.1 Safe Working Period & Production Date

The designed safe working period for this tester is 5 years, please refer to the factory inspection list for the production date.

### 2.2 General Rule

Please follow the user manual to use this tester.

### 2.3 Common Incorrect Operation

- 1) Tools for connecting is not well insulated.
- 2) Operating without following the user manual.

### 2.4 Damage Probably Caused By Incorrect Operation

- 1) Short circuit accident: Tools is not well insulated, or battery pack positive and negative electrodes are too close.
- 2) Failure to follow the correct operation method will cause the device not working properly.

### 2.5 Emergency Treatment In Exceptional Cases

Disconnect the device power supply and test cables.

### 2.6 Precautions In Exceptional Circumstances

If the operator uses tools without well insulation or improper operate to cause short circuit, please separate the cables immediately.

### 2.7 Other Safety Alerts

Strict compliance with safety operating norms and correct operating procedure.

### 3. Technical Features

Function Parameter	
Model	iSmartEV ED500
Power input	AC 90~265V
Charging & discharging voltage range	2~260V
Voltage measurement accuracy	$\pm 0.2\%FS + 0.1V$
Charging & discharging current range	0~ 100A
Current measurement accuracy	$\pm 0.5\%FS + 0.1A$
Test Power	Charge: 4.4kW max Discharge: 7.2kW max
Equalization Voltage	1.8~4.5V
Equalization Current	0~5A
Test Cell Qty	24
Temp Accuracy	$\pm 2^{\circ}C$ (-25 $^{\circ}C$ ~85 $^{\circ}C$ )
Charge Mode	constant current + constant voltage
Discharge Mode	Constant current + constant voltage
Protections	Overcurrent and overvoltage protection for input and output
Communication	CAN/RS485: cell data acquisition USB: data export & system upgrade
Safety Testing	
Breaking down test	AC input-metal shell: 2200Vdc 1min
	DC input-metal shell: 2200Vdc 1min
Working Environment	
Cooling	Forced air cooling
Temperature	Operating temperature: -5~40 $^{\circ}C$ ; Storage temperature: -20~70 $^{\circ}C$
Humidity	Relative humidity 0-90% (40 $\pm 2^{\circ}C$ )
Elevation	Rated altitude of 2000 meters
Size and Weight	
Dimension	643*404*540mm
Weight	42kg

## 4. Operating Instructions

### 4.1 Panel Description

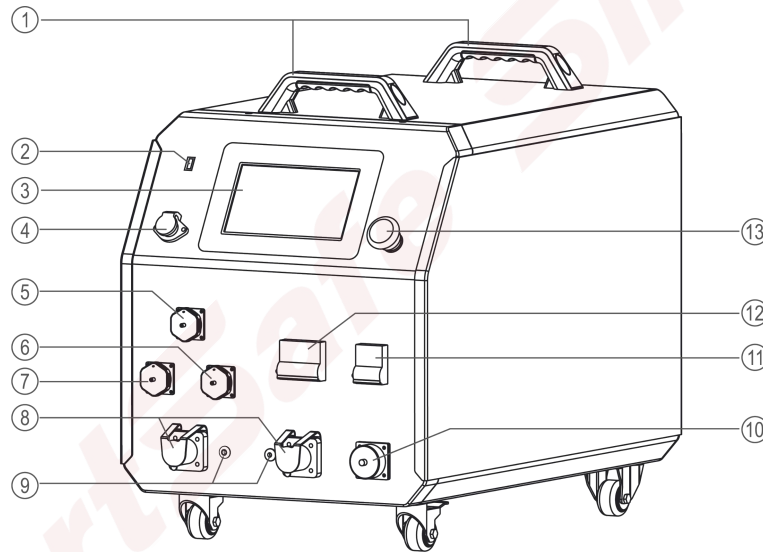

NO.	Part Name
1	Handle
2	USB Port
3	Display
4	Expansion Port
5	Temp Acquisition Port
6	Equalization Unit Port #2
7	Equalization Unit Port #1

NO.	Part Name
8	DC Test Cable Positive & Negative Interface
9	Voltage Sense Port
10	AC Input Socket
11	AC Breaker
12	DC Breaker
13	Emergency Stop Button

### 4.2 Interface Pin Definition

#### 1) 16 Pin Equalization port

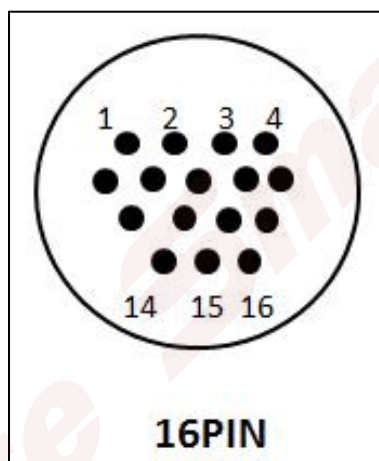

Pin_SN	Description	Line Marker	Pin_SN	Definition	Line Marker
1	Cell #1 -	B1-	9	Cell #8 +	B8+
2	Cell #1 +	B1+	10	Cell #9 +	B9+
3	Cell #2 +	B2+	11	Cell #10 +	B10+
4	Cell #3 +	B3+	12	Cell #11 +	B11+

5	Cell #4 +	B4+	13	Cell #12 +	B12+
6	Cell #5# +	B5+	14	Null	Null
7	Cell #6 +	B6+	15	Null	Null
8	Cell #7 +	B7+	16	Null	Null

**2) 24 Pin Temp port #2**

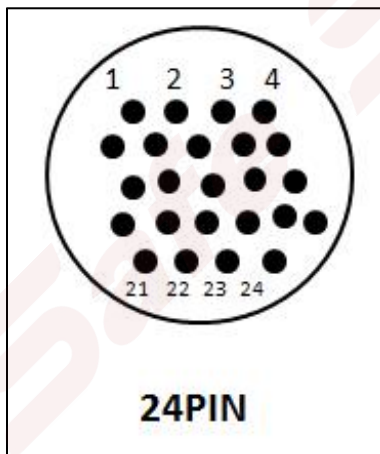

Pin_SN	Description	Line Marker	Pin_SN	Definition	Line Marker
24	Temperature Acquisition T4	T4	12	Null	Null
23			11	Null	Null
22	Temperature Acquisition T3	T3	10	Null	Null
21			9	Null	Null
20	Temperature Acquisition T2	T2	8	Null	Null
19			7	Null	Null
18	Temperature Acquisition T1	T1	6	Null	Null
17			5	Null	Null
16	Null	Null	4	Null	Null
15	Null	Null	3	Null	Null
14	Null	Null	2	Null	Null
13	Null	Null	1	Null	Null

**3) Expansion Port**

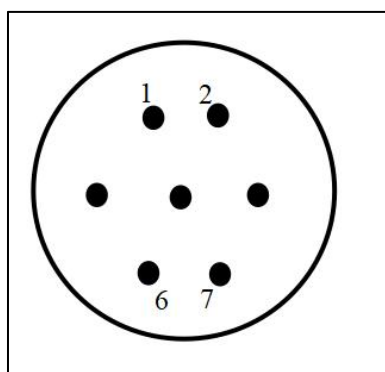

Pin_SN	Description
1	RS485 A
2	RS485 B
3	Micro_USB-VCC
4	Null
5	Micro_USB-GND
6	Micro_USB-D+
7	Micro_USB-D-

**4.3 Main Unit Connection**

**4.3.1 Working Power Supply Connecting**

Connect the power supply cord with the main unit AC socket, and select the corresponding power cord according to the load output connected to the power socket.



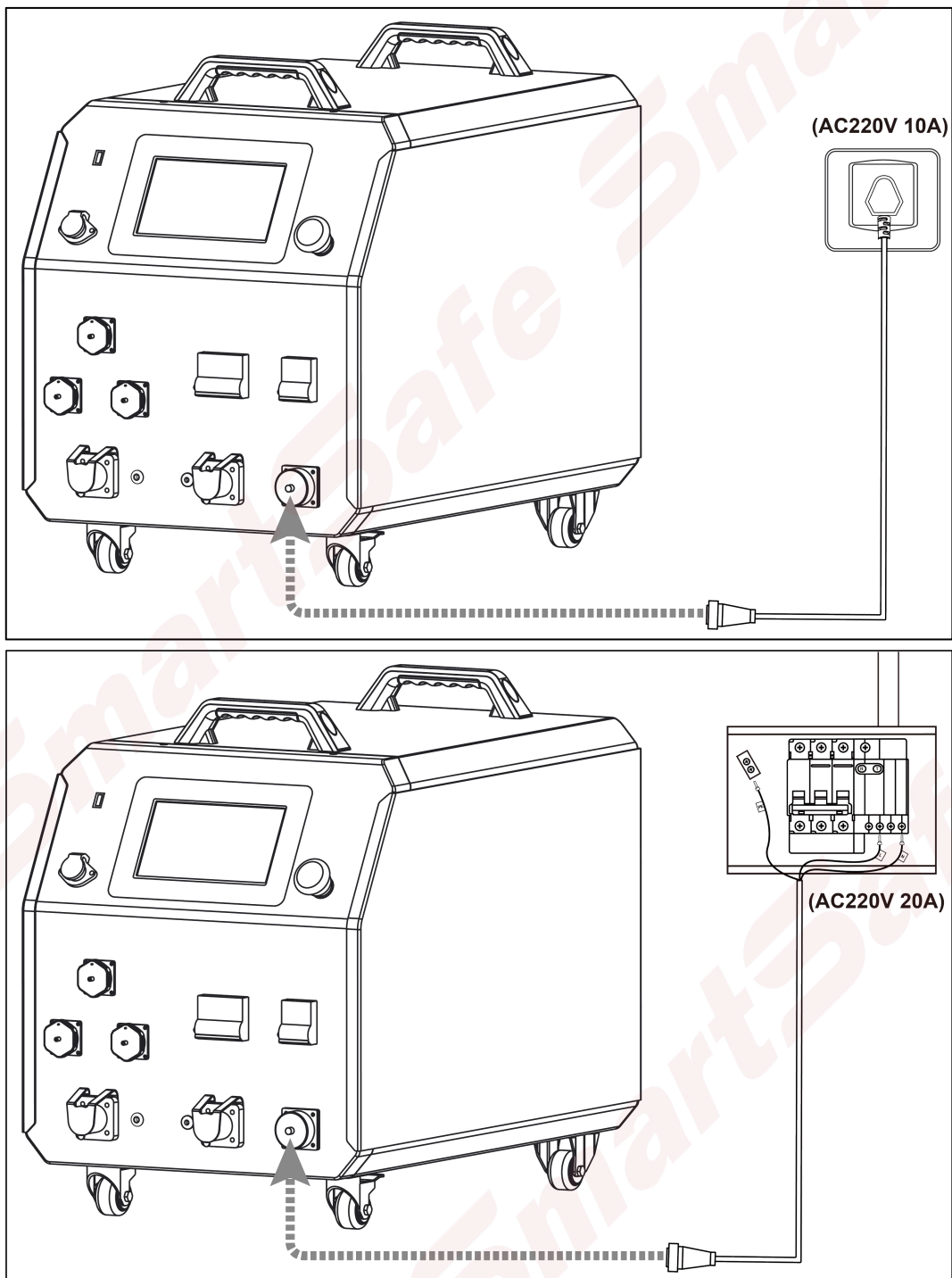

### 4.3.2 Discharge-Charge Test Scenarios

First, insert the DC test cable into the positive and negative interface of the equipment (red for positive and black for negative), and connect the other end of the DC test cable to both ends of the battery pack (red for positive and black for negative).

Then connect the equalization bus-harness to any equalizing test socket of the tester, and plug the equalization bus-harness and the equalization subharness,

Finally clamp the clamps of the equalization subharness on the battery module under test in turn.



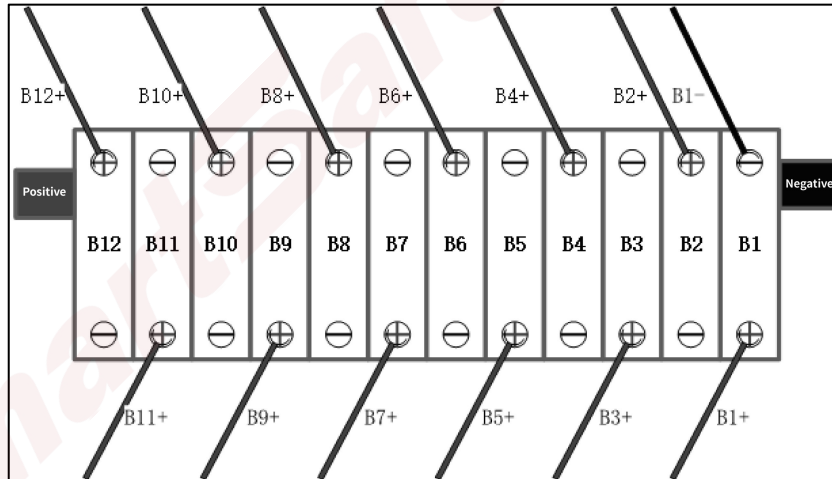
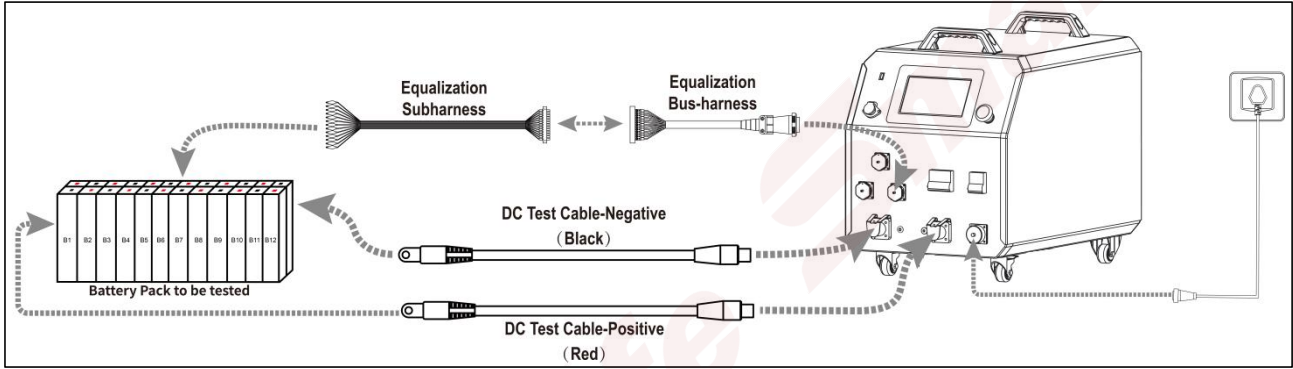

According to the wire label on the equalization subharness, B1 - is connected to the negative electrode of No. 1 single cell (B1), B1 + is connected to the positive electrode of No. 1 single cell (B1), B2 + is connected to the positive electrode of No. 2 single cell (B2), and connected in sequence.

*Note: the nearest to the negative terminal of the battery module is the No. 1 single cell.*

### 4.3.3 Equalization Test Scenarios

Firstly connect the equalization bus-harness to the equalizing test socket of the tester, then plug the equalization bus-harness and the equalization subharness, and finally clamp the clamps of the equalization subharness on the battery module under test in turn.

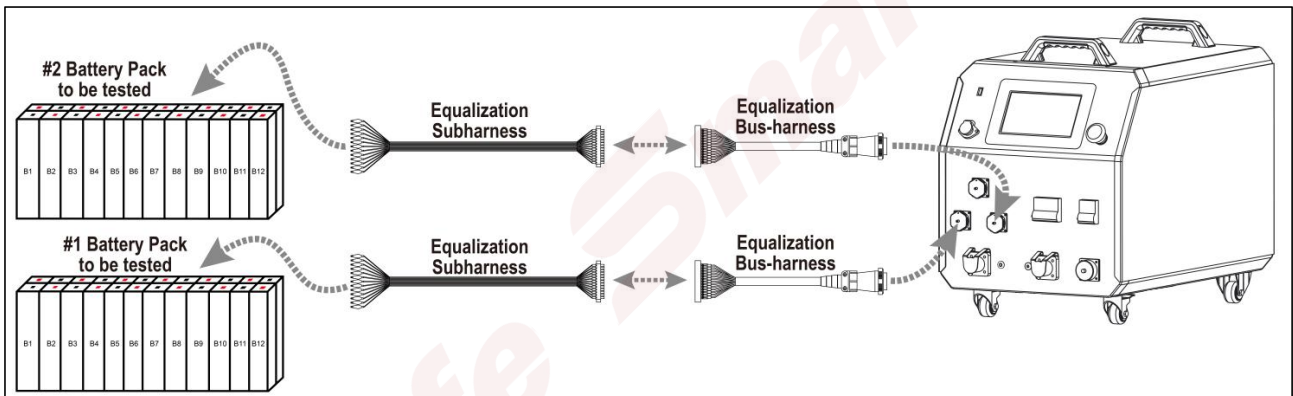

Please connect the cables strictly according to the instruction. For connecting with all plugs and sockets, please observe the positioning grooves and holes, confirm the plug's correct direction and check the connecting is fastened after joining.

## 4.4 Main Unit Operation

### 4.4.1 Welcome Screen



### 4.4.2 Main Menu

Click the function module on the main menu to enter the corresponding function operation interface.



### 4.5 Discharge & Charge

Click "Discharge-Charge" on the main menu to enter the corresponding function operation interface.

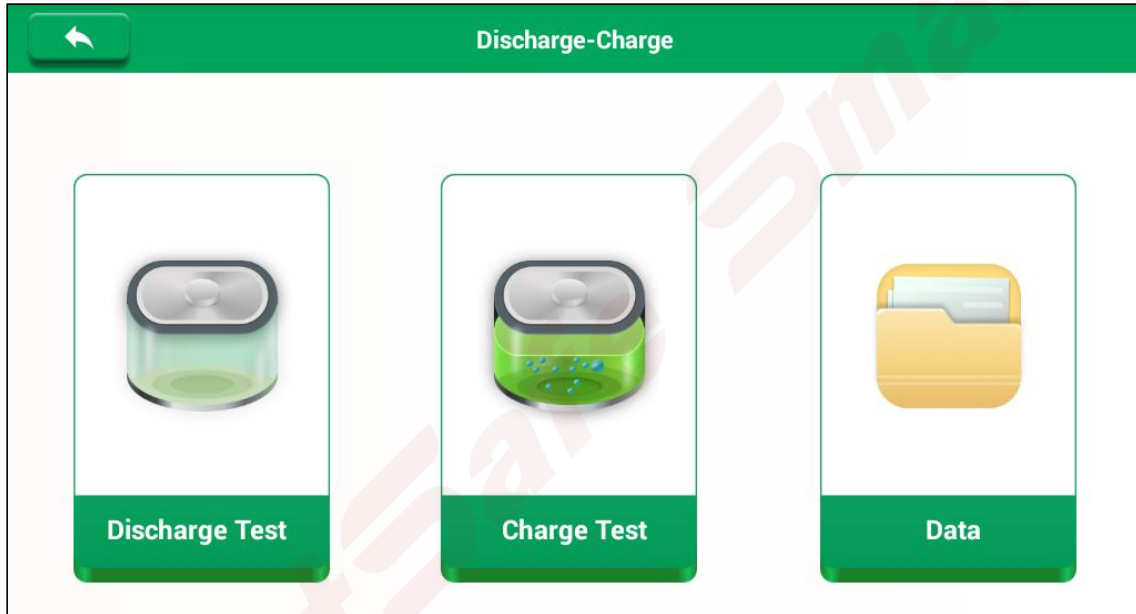

### 4.5.1 Discharge Test

1) The function "Discharge" is a single discharge test mode.

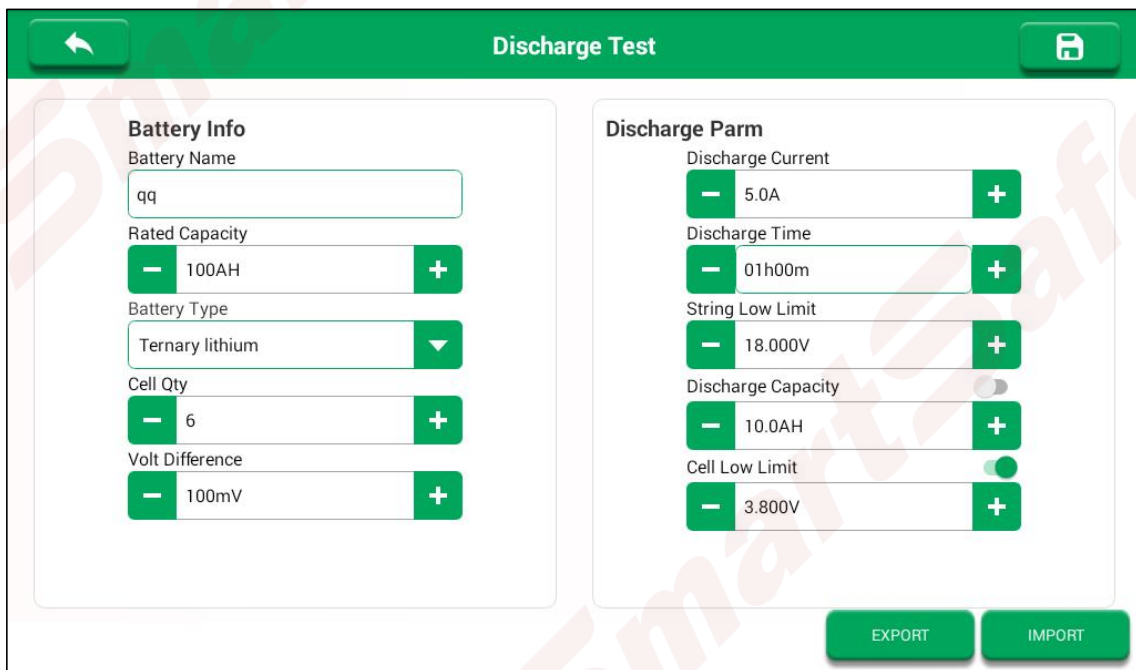

**Parameter Description :**

**Battery Information**

- Battery Name**  
The naming of the battery pack or module.
- Rated Capacity**  
The rated capacity of the battery pack, according to the actual input, can be identified from the rating plate.
- Battery Type**  
Select battery type.
- Cell Quantity**  
Fill in according to the actual number of strings.
- Cell Voltage Difference**  
Differential voltage protection value, one of the shutdown conditions.

**Discharge Parameters**

- Discharge Current**  
Discharge test current value.
- Discharge Time**  
Discharge test time setting, one of the shutdown conditions.
- String Low Limit**  
Group end voltage lower limit protection, one of the shutdown conditions.
- Discharge Capacity**  
Discharge capacity ah, one of the shutdown conditions.
- Cell Low Limit**  
Single string lower limit voltage protection value, one of the shutdown conditions.

2) Click  to save configuration and enter the test interface. Close the DC switch, tap **Start** to start the test.

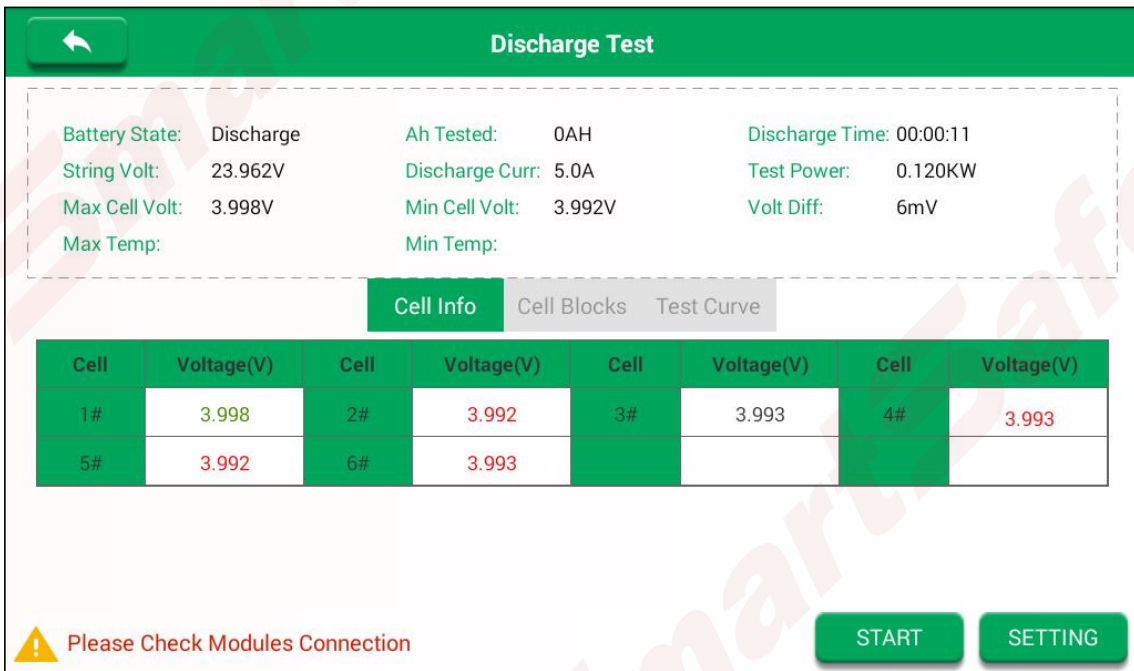

The current battery status, the test current, the test duration, the current voltage of the battery pack and the cell information can be viewed on the test interface. The configuration can be modified during the test.

- 3) In the process of threshold protection test, if any shutdown threshold is reached, it will stop automatically. Type of shutdown conditions: discharge time, lower limit of group end, pre-discharge capacity (in case of opening discharge capacity limitation) and cell lower limit (in case of opening discharge capacity limitation).
- 4) In addition to the above shutdown threshold protection, there are also multiple hardware protections: abnormal voltage of discharge module, abnormal current of discharge module, abnormal temperature of discharge module, short circuit protection and fan failure.

**4.5.2 Charge Test**

1) The function "Charge" is a single charge test mode.

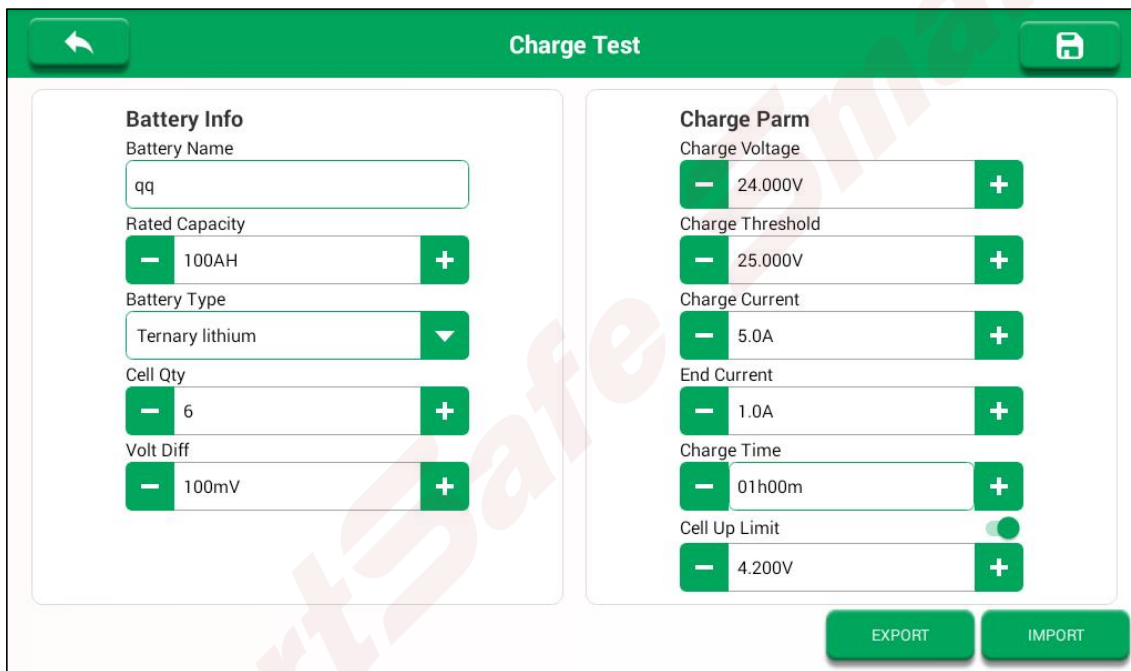

**Parameter Description :**

**Battery Information**

**Battery Name**

The naming of the battery pack or module.

**Rated Capacity**

The rated capacity of the battery pack, according to the actual input, can be identified from the rating plate.

**Battery Type**

Select battery type.

**Cell Quantity**

Fill in according to the actual number of strings.

**Cell Voltage Difference**

Differential voltage protection value, one of the shutdown conditions.

**Charge Parameters**

**Charge Voltage**

The target value of the charging voltage.

**Charge Threshold**

The upper limit voltage protection value of the group end, one of the shutdown conditions.

**Charge Current**

Charging test current value.

**End Current**

When the voltage reaches, the current is less than the value, then it stops, and one of the shutdown conditions.

**Charge time**

Charging test time, one of the shutdown conditions.

**Cell Up Limit**

Single core voltage upper limit protection value, one of the shutdown conditions.

2) Click  to save configuration and enter the test interface. Close the DC switch, tap **Start** to start the test.

←
**Charge Test**

Battery State: Charge	Ah Tested: 0AH	Charge Time: 00:00:06
String Volt: 23.976V	Charge Curr: 0.9A	Test Power: 0.023KW
Max Cell Volt: 4.000V	Min Cell Volt: 3.994V	Volt Diff: 6mV
Max Temp:	Min Temp:	

Cell Info
Cell Blocks
Test Curve

Cell	Voltage(V)	Cell	Voltage(V)	Cell	Voltage(V)	Cell	Voltage(V)
1#	4.000	2#	3.994	3#	3.996	4#	3.995
5#	3.995	6#	3.996				

⚠
Please Check Modules Connection

START
SETTING

The current battery status, the test current, the test duration, the current voltage of the battery pack and the cell information can be viewed on the test interface. The configuration can be modified during the test.

- 3) In the process of threshold protection test, if any shutdown threshold is reached, it will stop automatically. Type of shutdown conditions: charge time, current threshold, upper limit of cell voltage and group voltage.
- 4) In addition to the above shutdown threshold protection, there are also multiple hardware protections: charging module undervoltage protection, charging module overvoltage protection, charging module overtemperature protection, charging module overcurrent protection, short circuit protection and fan failure, etc.

### 4.5.3 Data Management

←
**Data**

<ul style="list-style-type: none"> <li><input type="checkbox"/> qq_20230105_181000.fbo</li> <li><input type="checkbox"/> qq_20230105_180836.fbo</li> <li><input type="checkbox"/> qq_20230105_180739.fbo</li> <li><input type="checkbox"/> qq_20230105_180555.fbo</li> <li><input type="checkbox"/> qq_20230105_180503.fbo</li> <li><input type="checkbox"/> qq_20230105_180419.fbo</li> <li><input type="checkbox"/> qq_20230105_175229.fbo</li> <li><input type="checkbox"/> qq_20230105_175111.fbo</li> <li><input type="checkbox"/> qq_20221230_091259.fbo</li> <li><input type="checkbox"/> qq_20221230_091231.fbo</li> <li><input type="checkbox"/> qq_20221230_091006.fbo</li> </ul>	<p><b>Test Time:</b> 2023-01-05 18:10:00</p> <p><b>Data Type:</b> Charge Data</p> <p><b>Stop Reason:</b> String Volt reached the threshold value.</p> <p><b>Rated Capacity:</b> 100AH</p> <p><b>Test Curr:</b> 5.0A</p> <p><b>Ah Tested:</b> 0AH</p> <p><b>Test Time:</b> 00:00:12</p> <p><b>Cell Low Limit:</b> 3.8V</p> <p><b>String Low Limit:</b> 20.0V</p> <p><b>Cell Qty:</b> 6Cells</p>
---	--

Select All
 SD:2.18G / 1.87G
DELETE
USB



Insert a U-disk into the USB port on the panel, select the data to be saved, and tap USB button to transfer the corresponding discharge data and charge data to the U-disk.

### 4.6 Equalization

Tap **Equalization** in the main interface to enter the following interface.

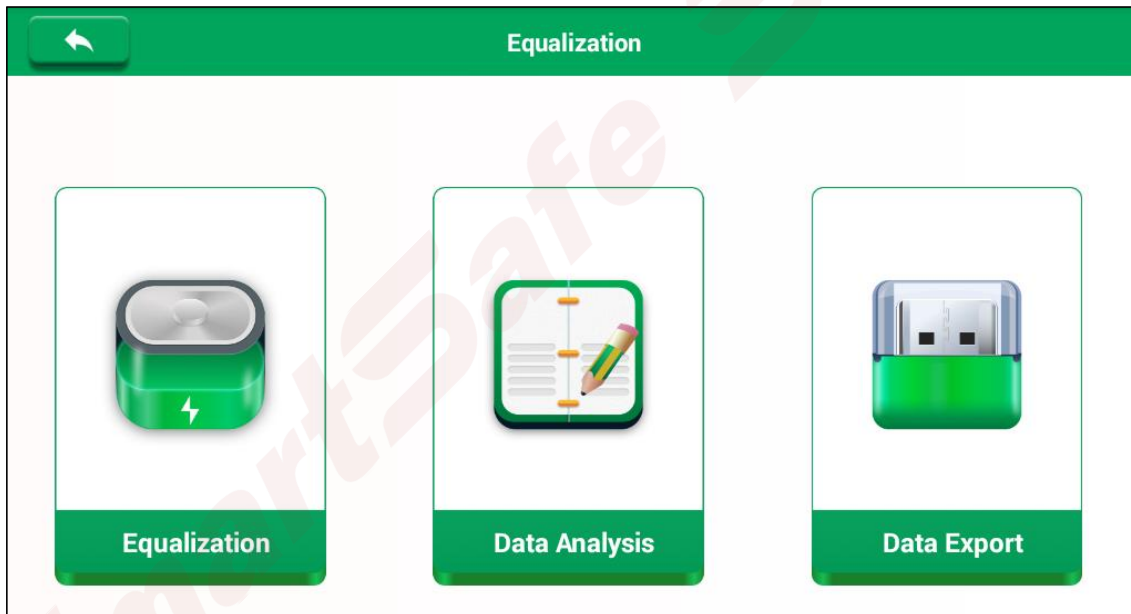

#### 4.6.1 Parameters

The tester can maintain at most 2 groups of batteries, each with 12 batteries (subject to the number of connected batteries).

When power on, if the battery pack is connected correctly, the current status of the battery pack will be displayed after the battery pack number. If the battery pack is not connected or there is a connection failure, the display status is: unconnected.

Equalization		
Item	1# Equalization Done	2# Unconnected
Test Mode	Equalization	Equalization
Test Time	00:00:37	00:57:08
Battery Type	Ternary	Ternary
Cell Qty	06/00	12/00
Target Voltage	3.850V	3.600V
Max Voltage	3.998V	---
Min Voltage	3.993V	---
Temperature		
Operation	▶ START	▶ START
	Setting    Details	Setting    Details



Parameters	Parameter Description	Parameters	Parameter Description
Item	Display the battery pack number and the status of the battery pack.	Test Mode	Charge, discharge or equalizing
Test Time	Work time since test started.	Battery Type	The type of lithium battery pack.
Cell Qty	Cell quantity in a battery pack.	Target Voltage	The end voltage to terminate the testing.
Max Voltage	The max voltage in all cells.	Min Voltage	The min voltage in all cells.
Temperature	Max temperature measured in battery pack.	Operation	Start/stop discharge, charge or equalizing.

### 4.6.2 Battery Pack Settings

On the "Equalization" interface, tap **Settings** button below the battery pack to enter the corresponding setting interface for the battery pack.

- 1) String Name: Enter the battery pack number or the corresponding information for testing to name it.
- 2) Test Mode: Click the drop-down menu to select the corresponding work mode (charge, discharge or equalizing).
- 3) Battery Type: Click the drop-down menu to select the appropriate lithium battery pack.

Parameter

String Name: aa Voltage Threshold(V): 3.850

Test Mode: Equalizing Current(A): 2.500

Battery Type: Ternary Cell Qty: 12

- Lithium iron phosphate
- Ternary
- Lithium Titanate
- Lithium Manganate

Test Object: All

4) Cell Qty: Click the drop-down menu to select the corresponding cell number of the test battery pack.

Parameter

String Name: aa Voltage Threshold(V): 3.850

Test Mode: Equalizing Current(A): 2.500

Battery Type: Ternary Cell Qty: 12

- 6
- 7
- 8
- 9
- 10
- 11
- 12

Test Object: All

5) Test Object: Click **Select All** to select all batteries; deselect all, then click the battery that requiring to be tested.

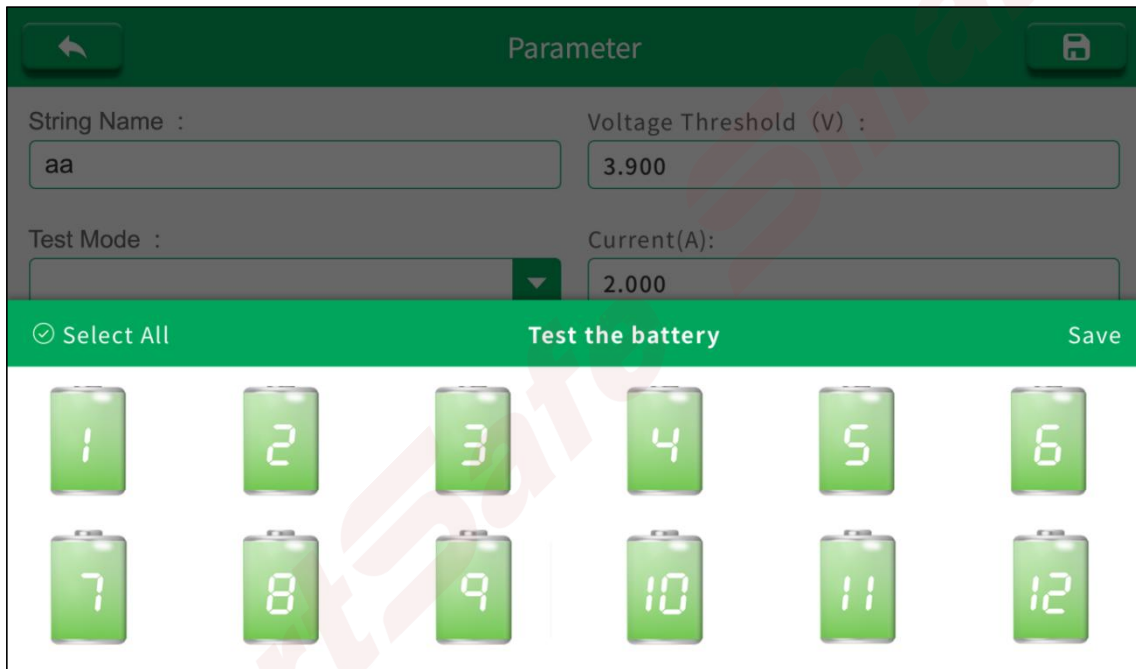

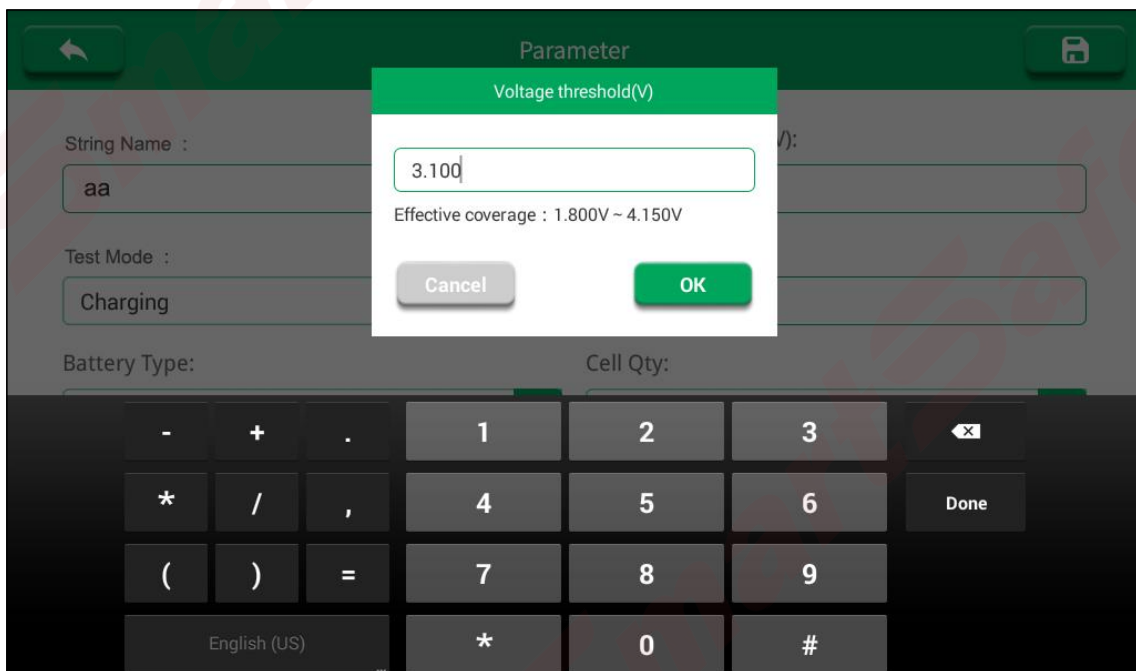

6) Voltage Threshold: Input the end voltage to terminate the testing.

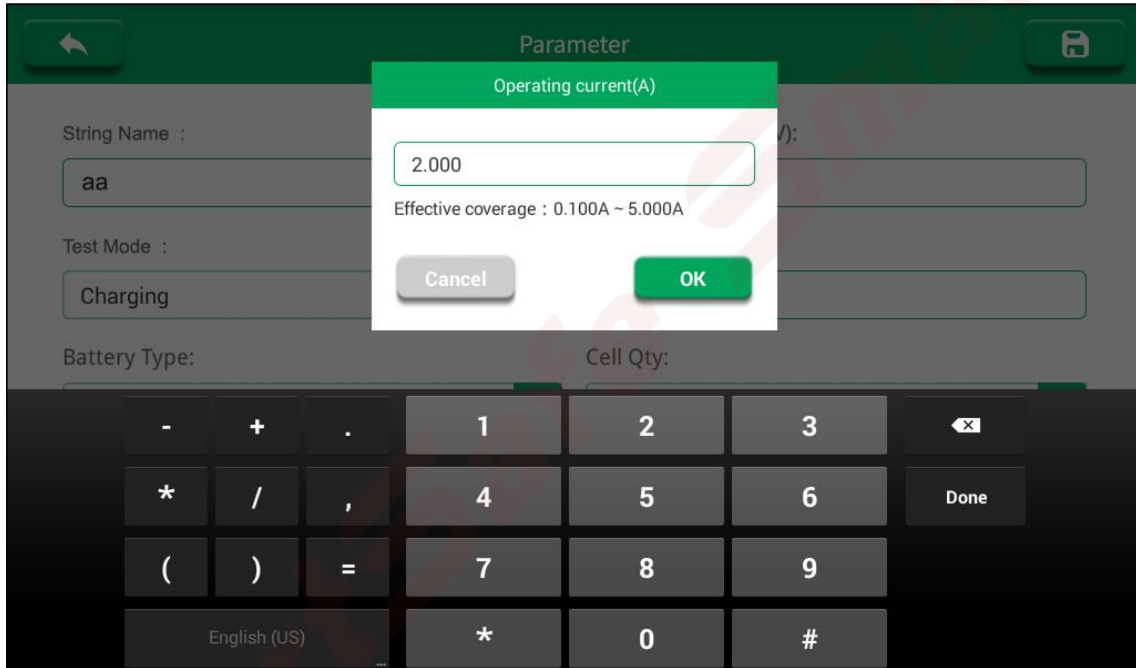

7) Current: Input the max discharge or charge current.



8) click  to save the adjustment, and click  back to the testing interface.

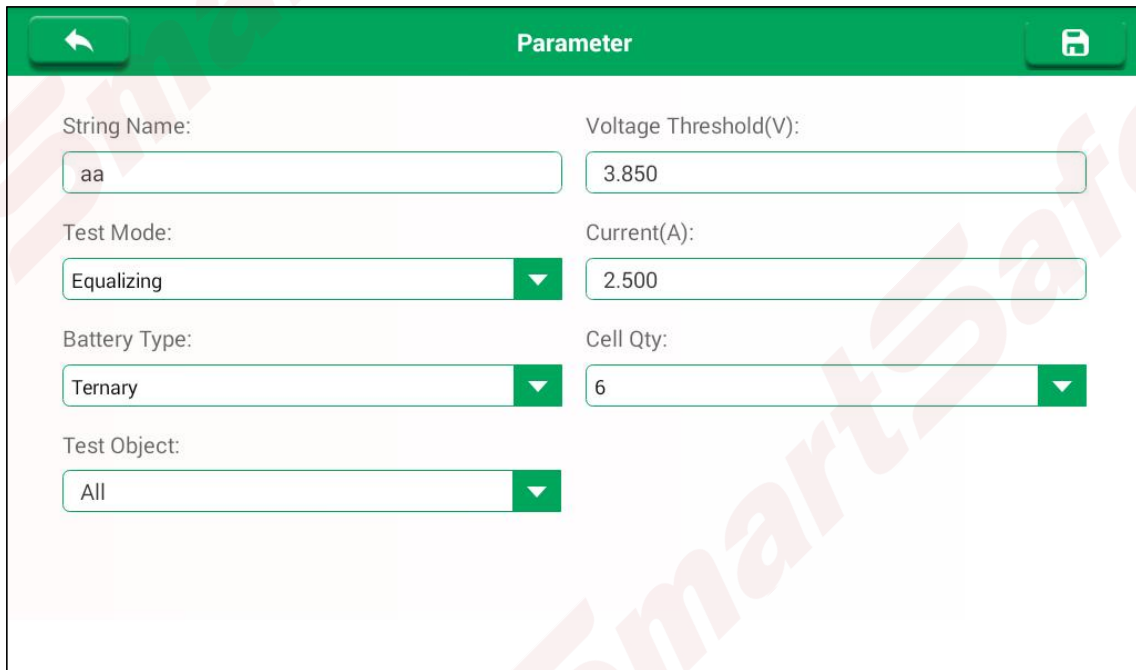

#### 4.6.3 Start the Test

1) On the "Equalization" interface, tap Start button to start the test.

Equalization		
Item	1#:Equalizing	2#:Unconnected
Test Mode	Equalization	Equalization
Test Time	00:00:14	00:57:08
Battery Type	Ternary	Ternary
Cell Qty	06/00	12/00
Target Voltage	3.850V	3.600V
Max Voltage	3.998V	---
Min Voltage	3.993V	---
Temperature		
Operation	START	START
	Setting Details	Setting Details

2) Tap **Details** to view parameters such as cell voltage, working current, working status, test duration, and capacity of the corresponding test battery pack.

Equalization						
Item	1#:Equalizing (00:00:06)					2#:Unconnected
Test Mode	No.	Voltage (V)	Current (A)	State	Capacity (Ah)	Equalization
	1#	3.998	2.521	Discharge	-0.001	
Test Time	2#	3.994	2.520	Discharge	-0.002	00:57:08
	3#	3.994	2.522	Discharge	-0.002	Ternary
Battery Type	4#	3.993	2.523	Discharge	-0.002	12/00
Cell Qty	5#	3.994	2.518	Discharge	-0.003	3.600V
Target Voltage	6#	3.993	2.516	Discharge	-0.003	---
Max Voltage						---
Min Voltage						---
Temperature						
Operation						START
	Work State					Setting

3) Equalization Finished Conditions:

- When the cell voltage reach the voltage threshold, and current is less than 0.2A over 3 mins, the unit will display **Finished** on this cell channel.
- All working cell channels display 'Finished', the whole equalization is complete.

#### 4.6.4 Data Analysis

After the test is completed, the test data is displayed in column chart or curve mode.

Tap **Bar Chart**, the test data voltage is displayed as a bar graph.

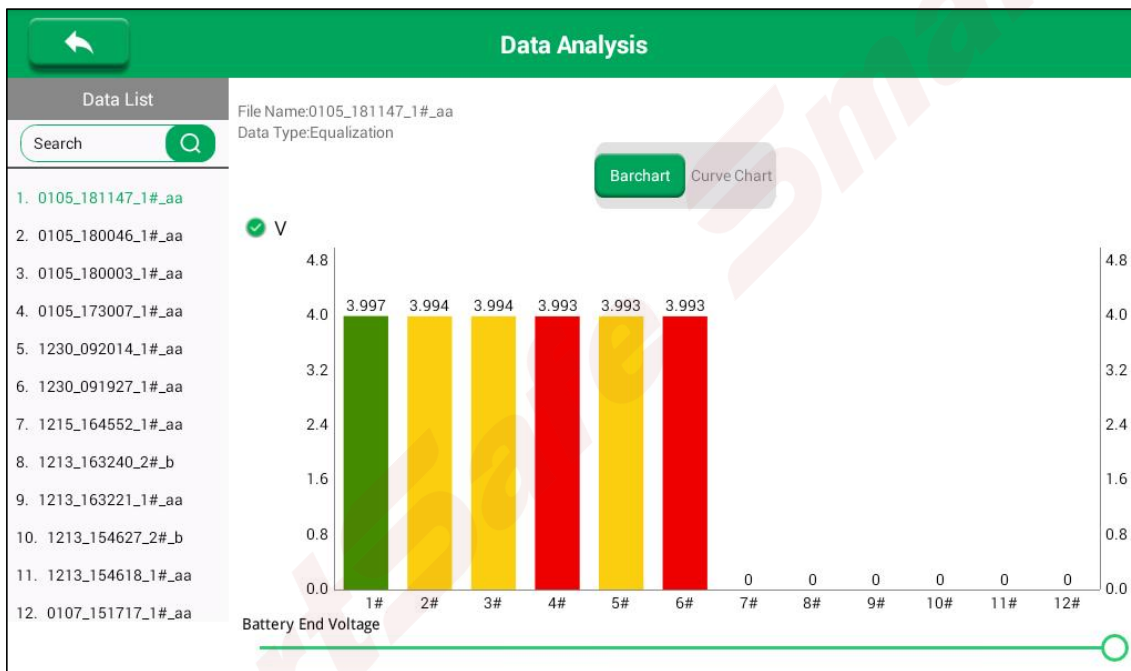

Tap **Curve Chart** to test the data voltage and display it as a curve graph.

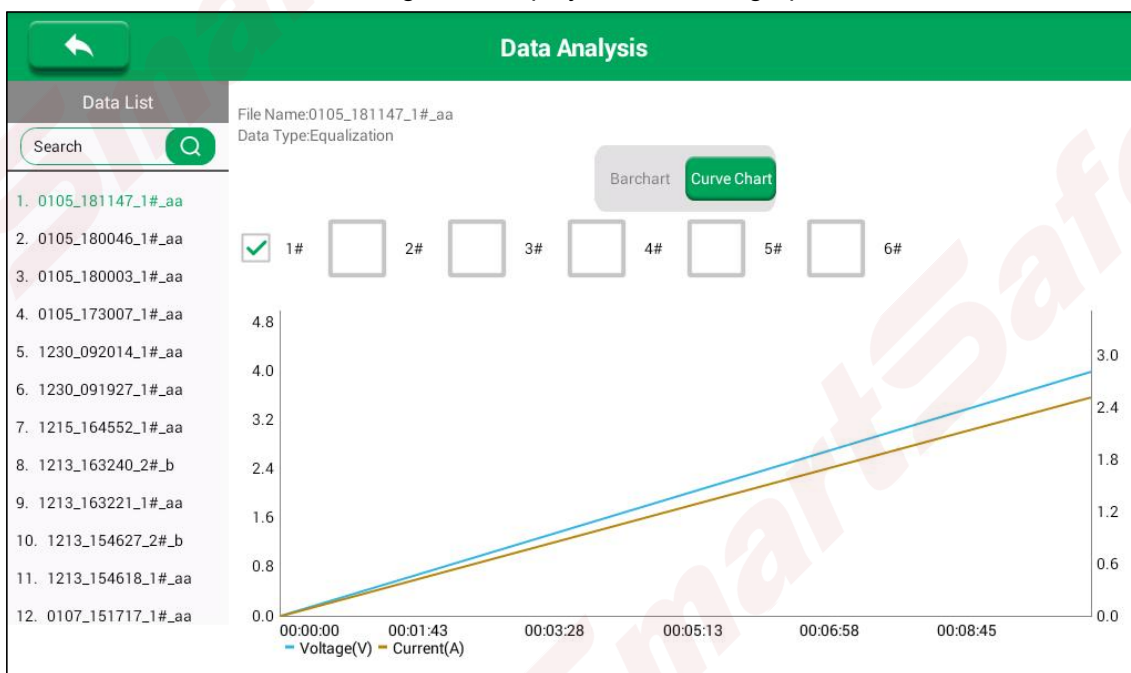

#### 4.6.5 Data Export

Test data can be transferred to U disk. On the main interface, tap Data Export to enter the data export interface, click the data to be transferred, insert a U disk and tap USB Download, the data will be stored in the U disk in Excel format.

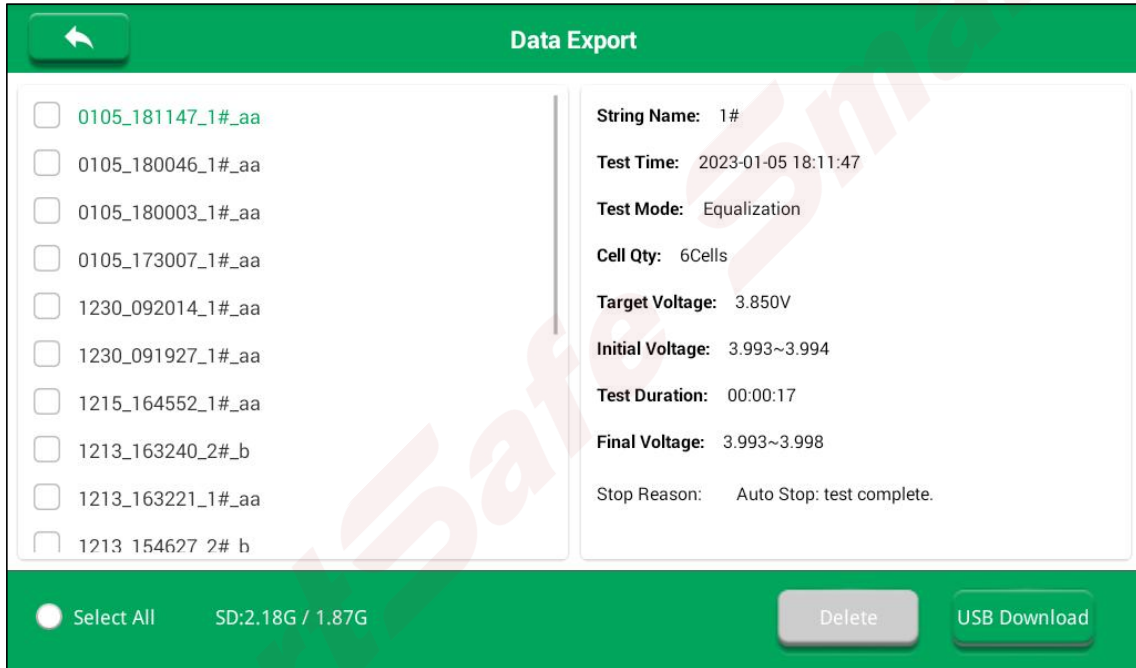

### 4.7 System Settings

Click "Setting" on the main menu to enter the corresponding function operation interface.



Discharge-Charge Setting: Used to set Discharge-charge parameters.



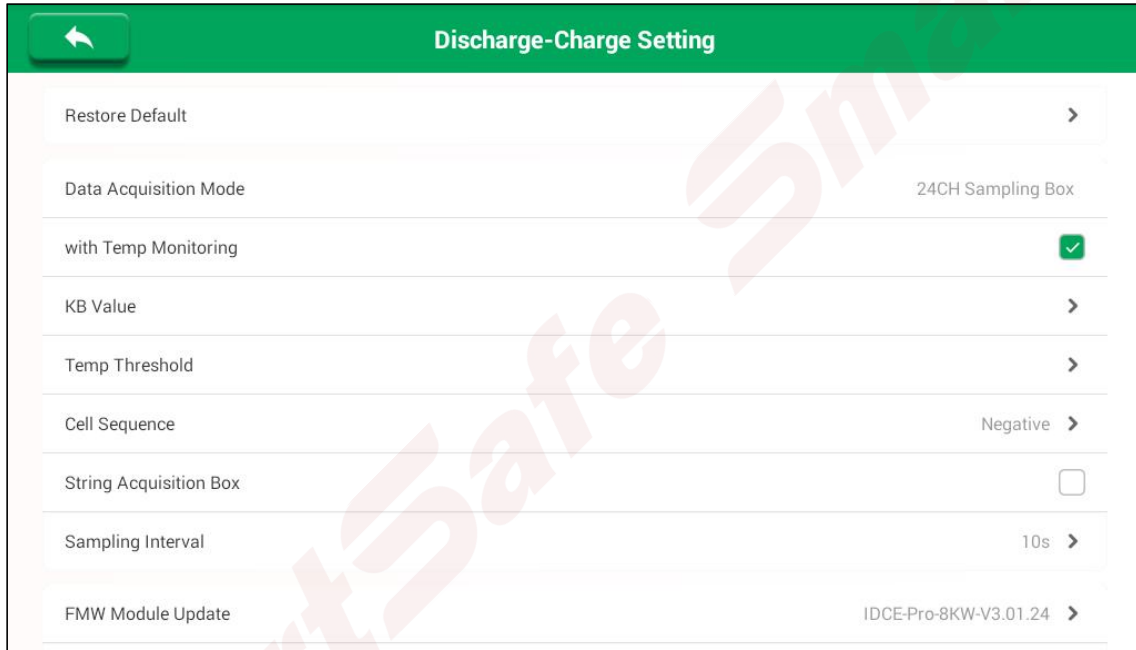

Equalization Setting: Used to set Equalization parameters.



Date & Time: Used to set the system date and time.

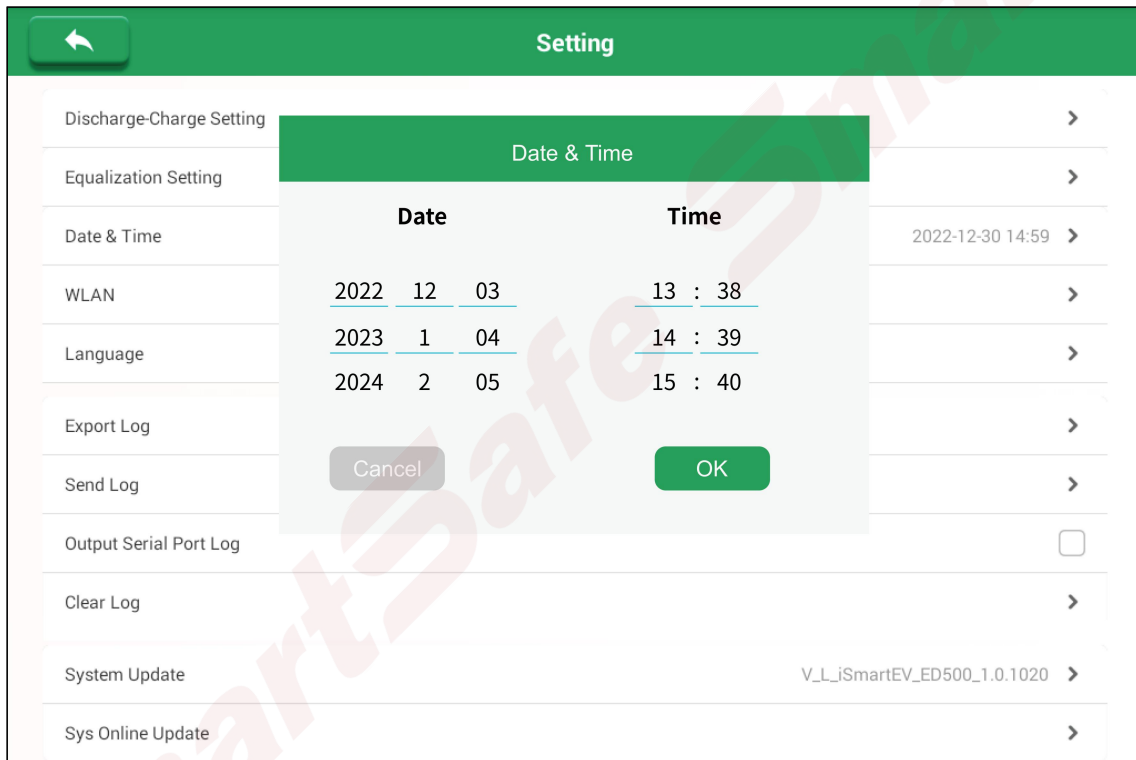

WLAN: Used for Wi-Fi connection setting of the tester.



Language: Used to change the system language.



Item	Description
<b>Export Log</b>	Used to export log files.
<b>Send Log</b>	Used to send log files.
<b>Output Serial Port Log</b>	Used to select / cancel output serial port log.
<b>Clear Log</b>	Used to clear logs.
<b>System Update</b>	Copy the upgrade package to the U disk. After connecting the equipment, select the corresponding upgrade package to upgrade.
<b>System Online Update</b>	Used to upgrade online after the equipment is connected to Wi-Fi.

## 5. Fault Analysis and Troubleshooting

No.	Fault Situation	Troubleshooting Methods
1	Main unit temperature is too high	Confirm the placement of the device, pay attention to ventilation, heat flow.
2	Internal memory insufficient	Periodically transfer data files to USB disk and delete some files to release the space
3	USB Error	Check the free space in USB disk

## 6. Transport & Storage

- 1) This tester is equipped with special equipment box for packing, which is has anti-vibration and reliable for transportation.
- 2) Storage conditions: dry storage room, temperature: -20~70℃, Humidity: 95%Within.

## 7. Environmental Protection and Others

- 1) The outer carton of this equipment is made of recyclable material.
- 2) The main unit and other components are non pollution sources.

## Warranty

THIS WARRANTY IS EXPRESSLY LIMITED TO PERSONS WHO PURCHASE SMARTSAFE PRODUCTS FOR PURPOSES OF RESALE OR USE IN THE ORDINARY COURSE OF THE BUYER'S BUSINESS.

SMARTSAFE electronic product is warranted against defects in materials and workmanship for one year from date of delivery to the user.

This warranty does not cover any part that has been abused, altered, used for a purpose other than for which it was intended, or used in a manner inconsistent with instructions regarding use. The exclusive remedy for any automotive meter found to be defective is repair or replacement, and SMARTSAFE shall not be liable for any consequential or incidental damages.

Final determination of defects shall be made by SMARTSAFE in accordance with procedures established by SMARTSAFE. No agent, employee, or representative of SMARTSAFE has any authority to bind SMARTSAFE to any affirmation, representation, or warranty concerning SMARTSAFE automotive meters, except as stated herein.

### Disclaimer

The above warranty is in lieu of any other warranty, expressed or implied, including any warranty of merchantability or fitness for a particular purpose.

### Purchase Order

Replaceable and optional parts can be ordered directly from your SMARTSAFE authorized dealer. Your order should include the following information:

- Order quantity
- Part number
- Part name

### Statement:

SMARTSAFE reserves the rights to make any change to product designs and specifications without notice. The actual object may differ a little from the descriptions in the manual in physical appearance, color and configuration. We have tried our best to make the descriptions and illustrations in the manual as accurate as possible, and defects are inevitable, if you have any question, please contact local dealer or after-sale service center of SMARTSAFE, SMARTSAFE does not bear any responsibility arising from misunderstandings.