

Trademark Information

SMARTSAFE is a registered trademark of SHENZHEN SMARTSAFE TECH. CO., LTD. (SMARTSAFE for short) in China and other countries. All other SMARTSAFE trademarks, service marks, domain names, logos, and company names referred to in this manual are either trademarks, registered trademarks, service marks, domain names, logos, company names of or are otherwise the property of SMARTSAFE or its affiliates. In countries where any of the SMARTSAFE trademarks, service marks, domain names, logos and company names are not registered, SMARTSAFE claims other rights associated with unregistered trademarks, service marks, domain names, logos, and company names. Other products or company names referred to in this manual may be trademarks of their respective owners. You may not use any trademark, service mark, domain name, logo, or company name of SMARTSAFE or any third party without permission from the owner of the applicable trademark, service mark, domain name, logo, or company name. You may contact SMARTSAFE by visiting SmartSafe at <http://www.newsmartsafe.com>, or writing to 3F, Building B, Qiao'an Technology Industrial Park, Guanlan, Longhua New District, Shenzhen, Guangdong, P. R. China, to request written permission to use Materials on this manual for purposes or for all other questions relating to this manual.

Copyright Information

Copyright © 2021 by SHENZHEN SMARTSAFE TECH. CO., LTD. All rights reserved. No part of this publication may be reproduced, stored in a retrieval system, or transmitted in any form or by any means, electronic, mechanical, photocopying, recording or otherwise, without the prior written permission of SMARTSAFE. The information contained herein is designed only for the use of this unit. SMARTSAFE is not responsible for any use of this information as applied to other units.

Neither SMARTSAFE nor its affiliates shall be liable to the purchaser of this unit or third parties for damages, losses, costs, or expenses incurred by purchaser or third parties as a result of: accident, misuse, or abuse of this unit, or unauthorized modifications, repairs, or alterations to this unit, or failure to strictly comply with SMARTSAFE operating and maintenance instructions.

SMARTSAFE shall not be liable for any damages or problems arising from the use of any options or any consumable products other than those designated as Original SMARTSAFE Products or SMARTSAFE Approved Products by SMARTSAFE.

General Notice

Other product names used herein are for identification purposes only and may be trademarks of their respective owners. SMARTSAFE disclaims any and all rights in those marks.

The equipment is for specialist or qualified technician use only.

Disclaimer

- All information, illustrations, and specifications contained in this manual are based on the latest information available at the time of publication.
- SmartSafe reserves all the rights to make changes at any time without notice.

Safety Precautions

Read all service procedures and precautions, installation instructions and equipment operating manuals thoroughly. Failure to observe these precautions, or the improper use of equipment, could result in property damage, serious injury or death. Never allow improperly trained personnel to perform these procedures or operate equipment.

- Read and understand the User's Manual before attempting to operate the iSmartATF 501.
- Do not smoke in proximity to the machine while it is in operation.
- Do not use the machine in proximity to sources of heat and fire.
- Do not expose to direct sunlight or rain, use in well-ventilated work area only.
- Turn off the power after the operation is completed.
- When it is in operation, keep the hoses away from rotating elements and hot parts such as cooling fans, radiators, etc.
- Vehicle exhaust includes various poisonous and harmful gases (such as carbon monoxide, hydrocarbon, nitrogen oxygen complex, etc.). Keep the unit in a well ventilated work area when performing operation and wear safety goggles, respirator and clothes.
- The operator should keep away from the heat parts such as exhaust hoses and radiator to avoid the personal injury.
- When disconnecting any connector of the pressurized fluid pipe, wrap the connector with towel to prevent the fluid from spurting out.
- The children and mental retardation personnel should keep away from the unit during operation.
- The operator should be quite familiar with the shift of automatic transmission to avoid transmission damage caused by improper operation.
- Always make the drive wheels hanging when cleaning the transmission or exchanging fluid.
- The unit should be placed vertically and should not be placed upside down.
- When changing fluid, the operation should be performed by properly trained personnel. The quality of the selected ATF must conform to the direction as specified in the manual of the auto to be operated. Otherwise, SMARTSAFE shall not be liable for any direct or consequential damages.



Note: specifying operations that require attention when operating the equipment.



Warning: Specifying a possible hazard that could result in damage to the machine or personal injury.

Table of Contents

Introduction.....	1
Features.....	1
Working Conditions.....	1
Specifications.....	1
Structure.....	1
1. Outline.....	1
2. Overall structure.....	2
3. Pipeline diagram.....	3
4. Circuit connection diagram.....	3
5. Control panel.....	4
Operations.....	6
1. Preparation.....	6
1.1 Jack vehicle.....	6
1.2 Connecting hose.....	6
1.3 Power cables connection.....	6
1.4 Check-up.....	6
2. Filling liquid.....	7
2.1 Filling detergent.....	7
2.2 Adding new oil.....	7
3. Circulating cleaning.....	7
3.1 Fill detergent to auto transmission.....	7
3.2 Circulating cleaning.....	7
3.3 Finish circulating cleaning.....	7
4. ATF exchange.....	7
4.1 Direct Input.....	8
4.2 Vehicle Selection enter.....	8
5. Adjusting fluid level.....	9
5.1 Increase fluid amount.....	9
5.2 Decrease fluid amount.....	10
6. Empty new fluid tank.....	10
7. Empty used fluid tank.....	10
8. System setting.....	10
8.1 Sensor calibration.....	11
8.2 Select transmission fluid.....	12
8.3 Window Light Switch Setting.....	12
8.4 LCD Screen Brightness Adjustment.....	13
8.5 Date & Time.....	13
8.6 Language setting.....	14
8.7 Vehicle Adding.....	14
8.8 Print Setting.....	15
8.9 History Records.....	15
8.10 Device information.....	15
Warning.....	16
Maintenance.....	16
Main adapters.....	16

Introduction

The transmission fluid inside transmission will go bad after a period of usage of automatic transmission. If the transmission fluid cannot be changed completely in time, it may cause the abnormality to the transmission. Generally speaking, Auto Transmission Cleaner and Fluid Exchanger cannot control the filling quantity of the ATF as required, the excessive or shortage filling will cause the damage to auto transmission. CAT-501S auto transmission cleaner and fluid exchanger can complete the flush and fluid exchange in 20 minutes for transmission, torque converter and radiator. The fluid exchange rate is nearly 100%.

Features

- LCD display and personalized design making easy operation.
- Multi-language print.
- Filling and recycling of automatic transmission fluid.
- Automatic identification for the fluid flow inlet/outlet direction.
- Circulating cleaning for automatic transmission.
- Easy for detergent filling.
- Automatic exchange of new/used fluid.
- Visual display of the fluid pressures.
- Accurate display of the automatic transmission fluid temperature.
- Intelligent electronic control for the full automatic equivalent exchange of new and used fluid.
- Manually adding and upgrading database function.
- Various special adapters are applicable to vehicle types made in Europe, America and Asia.
- Effectively resolve the incomplete fluid exchange of manual operation.
- It improves the working performance of auto transmission.
- It prolongs the work life of transmission.

Working Conditions

- Ambient temperature: -10~+50°C
- Relative humidity: <90%

Specifications

- Power supply: 110V-127V~,50Hz/60Hz
220V-230V~,50Hz/60Hz
- Maximum power: 150W
- Pressure gauge: 0~150psi
- Fluid outlet hose: 2.5 m
- Fluid return hose: 2.5 m
- Fluid draining hose: 1.2 m
- Filter precision: 5μm
- Filter life span: about one year if using one time a day
- Fluid tank: 20L×2
- Equivalent exchange error: ±100ml
- Mean exchange speed: 2L/MIN
- Noise: <70db
- Net weight: 70Kg
- Gross weight: 78Kg
- Size: 590mm×700mm×1037mm

Structure

1. Outline

As shown in Fig.1, CAT-501S is designed with a fine cabinet. There is a handle at the top of cabinet and two pairs of casters at the bottom of the cabinet, which makes it easy to move the unit. Fluid hoses are equipped with proper connectors for fast connection. The intelligible control panel helps you operate the machine easily.

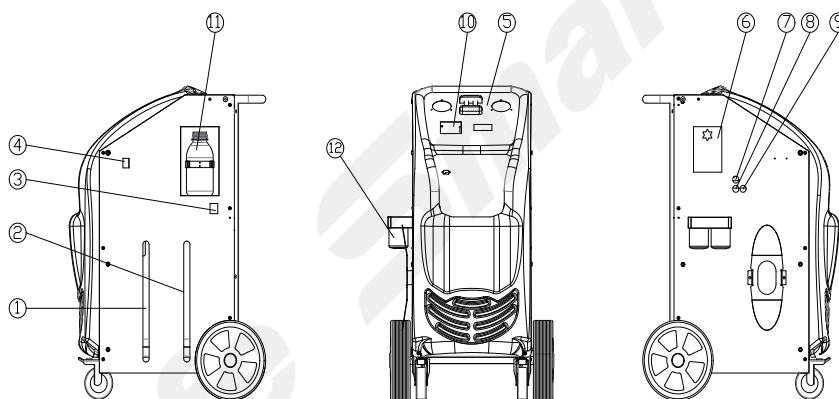

Fig.1

- 1- Sight indicator of used fluid; 2- Sight indicator of new fluid; 3- Power plug hole; 4- Power switch; 5- Operation screen; 6- Fluid filling port; 7- Fluid draining hose; 8,9- Hoses; 10-Printer; 11-Detergent container; 12-filter.

2. Overall structure

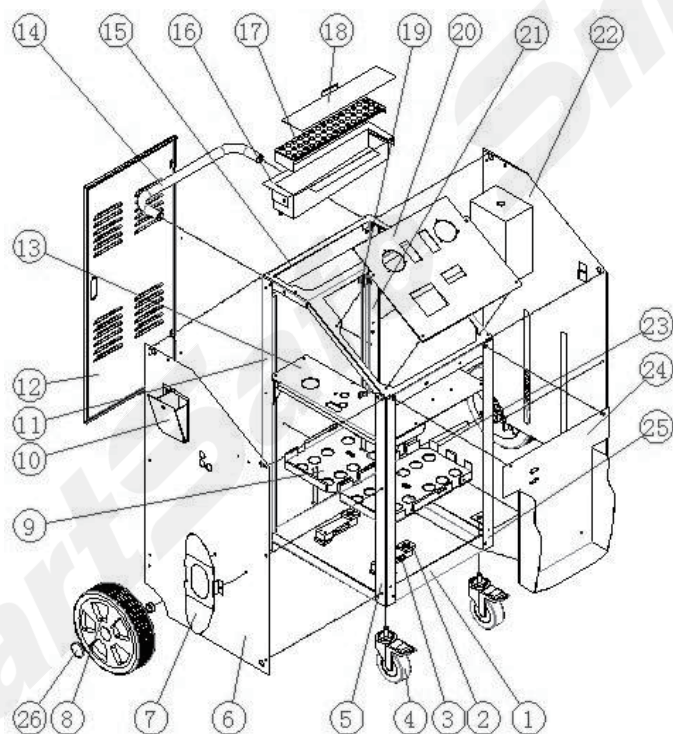

Fig.2

SN	Name	SN	Name
1	Bottom board	14	Handle
2	Electronic scale pan cushion plate	15	Top board
3	Electronic scale sensor	16	Oil trap
4	Front caster	17	Filter plate
5	Front right post	18	Oil trap cover board
6	Right side board	19	Lower hinge joint welding body
7	Hose brackets	20	Control panel
8	Back caster	21	Rear left post
9	Tray for tank	22	Left side board
10	Filling bucket	23	Caster axle
11	Rear right post	24	Front board
12	Door board	25	Front left post
13	Middle spacer plate 01	26	Cover of back caster

3. Pipeline diagram

The pipeline diagram is as shown in Fig.3.

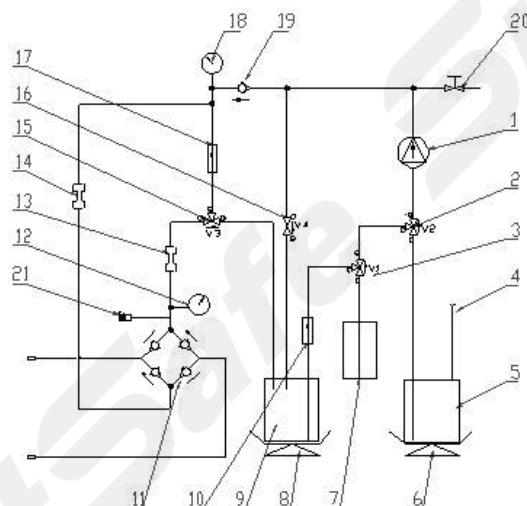

Fig.3

1-Pump; 2,3,15-Three-way solenoid valves; 4-Fluid filling port; 5-New fluid tank; 6,8-Electronic scales; 7-Detergent container; 9- Used fluid tank; 10,17-Filters; 11- Fluid path identifier; 12,18- Pressure gauges 13,14- Sight indicators; 16-Two-way solenoid valve; 19- Check valve; 20- Ball valve for fluid draining; 21- Temperature sensor.

4. Circuit connection diagram

The circuit connection diagram is as shown in Fig.4.

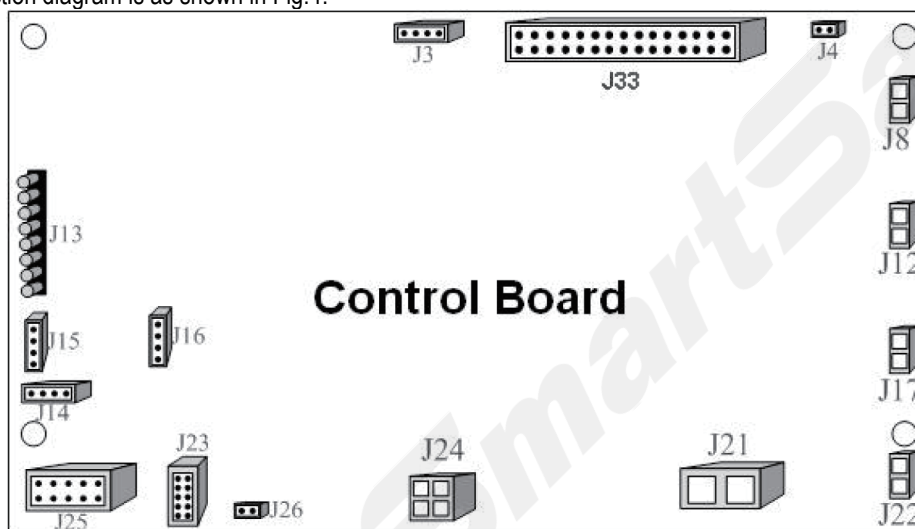

Fig.4

J8	To solenoid V2	J25	To unit serial port cable
J12	To solenoid V1	J14	To temperature sensor
J17	To solenoid V3	J15	To used fluid tank sensor
J22	To solenoid V4	J16	To new fluid tank sensor
J21	To oil pump	J13	To key-press film
J24	To switch power supply	J33	To VGA display and drive module
J26	To printer power supply	J3	Test port, used by SMARTSAFE only
J23	To printer data cable	J4	To sight indicators for used & new fluid

5. Control panel

The control panel is as shown in Fig.5.



Fig.5

Description:

Element	Description
NEW	Observe the flow rate and compare the color of new and used fluid. Display the fluid outlet pressure. Display the fluid pressure of AT radiator.
USED	
↑	Press it to select function option in main menu.
↓	Press it to select function option in main menu.
ENTER	Confirmation.
RETURN	<ol style="list-style-type: none"> Menu to return. Press one time to stop current operation, and press once more to return to previous interface.
DEL	Press to delete the previous character in focused window, and in database interface, press it you can delete some menu item.
LIGHT	<ol style="list-style-type: none"> In main-menu, you can switch on/off the lights of sight indicators. In focused window, press it you can enter the character of ".". When entering some menu option on database interface, press it you can switch between uppercase and lowercase letters.
0(A, B, C)	
1(D, E, F)	
2(G, H, I)	
3(J, K, L)	
4(*)	
5(M, N, O, P)	
6(Q, R, S)	
7(T, U, V)	
8(W, X, Y, Z)	
9(#)	

1. Startup interface: (As shown in Fig.6)

In the startup interface press any key to enter the upgrade multilingual document interface.

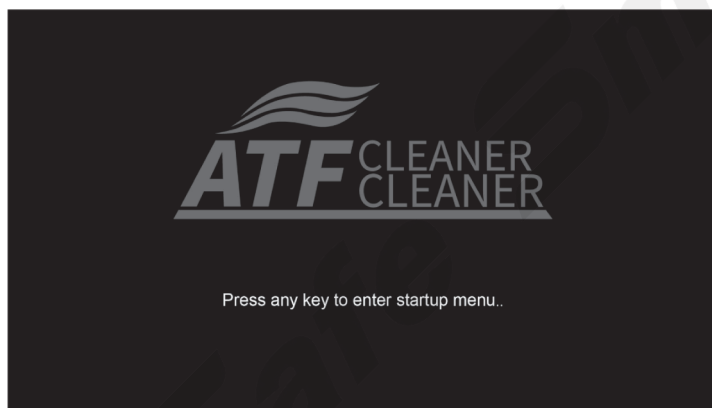

Fig.6

2. The main menu of display screen is as shown in Fig.7.



Fig.7

Item	Description
Add detergent	Add ATF detergent to AT
Exchange	Exchanging ATF
Adjust fluid level	Adjusting the quantity of fluid inside AT
Empty new tank	Draining left fluid inside new fluid tank
Empty used tank	Draining used fluid inside used fluid tank
System setting	Modifying the system parameter, e.g.: Calibration of electronic scale, adjusting contrast, language selection, database entry.

Operations

Note:

During the unit is in operation, it will produce the vibration with a certain frequency and noise. This is the normal performance. Do not take it as the malfunction.

1. Preparation

1.1 Jack vehicle

Jack the vehicle to keep the drive wheel off the ground at least 200mm, apply the parking brake and block the driven wheels in front and behind.

1.2 Connecting hose

- 1) Locate the fluid hose that is connected between the radiator and transmission at the most convenient location and then disconnect the adaptor. Locate the matched connector inside the connector box and connect it to the disconnected adapter.
- 2) Connect the two hoses marked "TO TRANSMISSION" of CAT-501S to the disconnected two ends of the hoses of automatic transmission (no necessary to consider the direction of the fluid flow). Refer to Fig.7.

1.3 Power cables connection

Connect the power cables of the main unit to the designed power supply.

1.4 Check-up

- 1) Start the engine, and ensure that there is no leakage in pipeline.
- 2) Confirm that the power supply of the iSmartATF 501 is normal, and then switch on the unit.

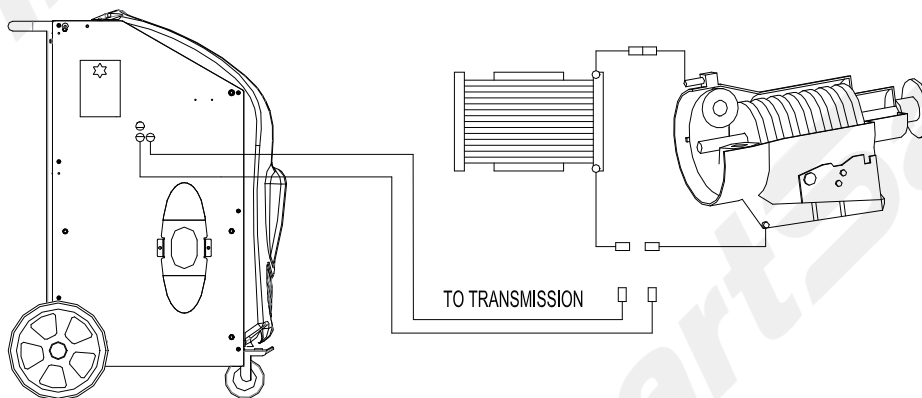

Fig.8

2. Filling liquid

2.1 Filling detergent

When you are ready to perform the circulating cleaning for auto transmission, please fill proper amount of detergent into the detergent container (please refer to Fig.3).

2.2 Adding new oil

When you are ready to perform the ATF exchange operation, please fill new fluid into the new fluid tank from the fluid filling port (please refer to Fig.3).

3. Circulating cleaning

3.1 Fill detergent to auto transmission

- 1) Select the function of "Add ATF detergent" in main menu, and set the amount of the detergent to be filled (the setting range: 0.00-0.50 L). Refer to Fig.9.

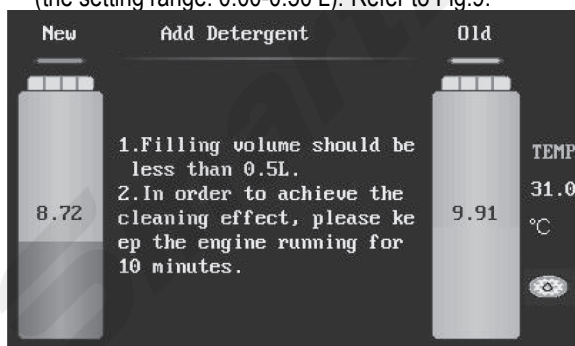

Fig.9

Note: Fill detergent before need to calibrate cleaning speed (see "cleaning speed" sensor calibration content).

- 2) Input the amount to be filled. The default value of the unit is 0.20L and the maximum value is 0.50L. Press ENTER key after the amount to be filled is confirmed, the detergent filled inside the detergent container will be pumped into the hose.

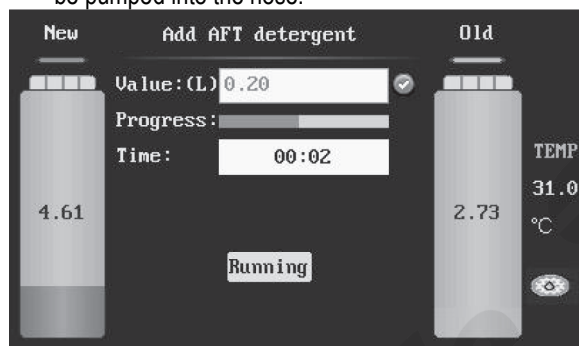

Fig.10

- 3) After the filling operation is finished, the system will automatically pop up print menu. Press ENTER key select print, press RETURN key to cancel printing. Refer to Fig.11



Fig.11

- 4) Print is completed or cancelled, will pop up 10 minutes cycle cleaning countdown. Refer to Fig.12.

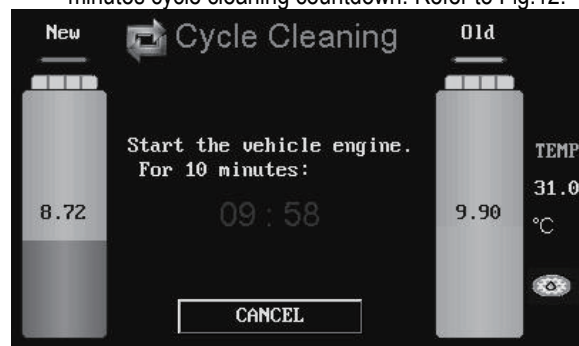

Fig.12

3.2 Circulating cleaning

After the detergent is filled into the hose, start the engine and the fluid will circulate from the CAT-501S pipelines to the Automatic Transmission. In order to speed up the circulating process, it is advisable to perform the gear-shift operation (The running time for each gear-shift should be kept for about 1 minute, which depends on actual situation. When the vehicle engine is running with high-speed, the speed should be more than 60 km/h to ensure the effect of cleaning).

The circulating cleaning option is not set in CAT-501S main menu. When the hoses are well connected, start the vehicle engine and the unit will enter the circulating process automatically. If the cleaning circulation operation is needed for a long period of time, please turn off the power supply of CAT-501S.

3.3 Finish circulating cleaning

After the circulating cleaning operation has been lasted for more than 10 minutes, please turn off the engine to end the circulating cleaning process.

4. ATF exchange

When different kind of fluid is used or the unit is stored for a long time, about 0.5L new fluid should be filled into new fluid tank. With the way of emptying the new fluid tank, clean the fluid hoses and drain the air bubbles out from the unit.

- 1) Start the vehicle to warm up the fluid inside the transmission to normal temperature and fill the new transmission fluid with desired amount into it.
- 2) Check if the pipelines are well connected.
- 3) ATF exchange: as shown in Fig.13, you can directly input the fluid amount to be changed, as well as you can obtain the amount by selecting Vehicle Selection option.

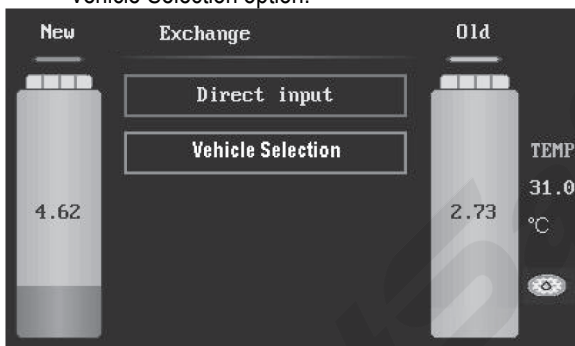

Fig.13

4.1 Direct Input

Select Direct Input, and press ENTER key to enter into the next interface, and then input the fluid amount to be changed (the default value is 10L), as shown in Fig.14.

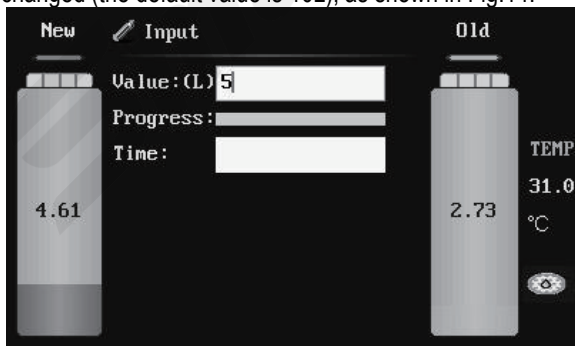

Fig.14

Be sure that there is no leak in the pipelines and press ENTER key to exchange, as shown in Fig.15.

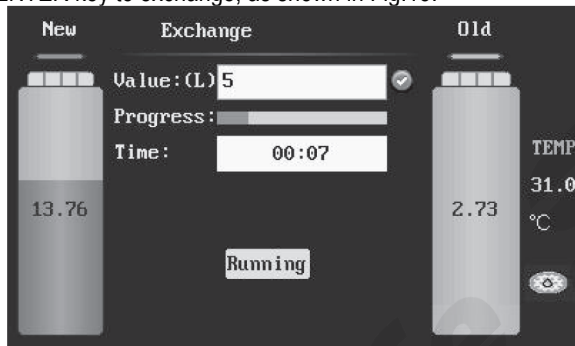

Fig.15

After the exchange operation is finished, the system will automatically pop up print menu. Press ENTER key select print, press RETURN key to cancel printing. Refer to Fig.16



Fig.16

Print is completed, the system will return to the interface as shown in Fig.13.

4.2 Vehicle Selection enter

Select Vehicle Selection option, and press ENTER key you can see the vehicle model menu as shown in Fig.17.

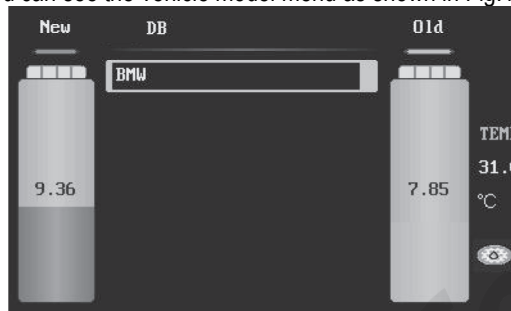

Fig.17

Select the menu path of the specific vehicle model to enter the testing interface which displays the fluid amount to be changed, as shown in Fig.18. If the testing is not passed, the screen will display the operations which need to be performed, as shown in Fig.19, Fig.20, Fig.21 and Fig.22

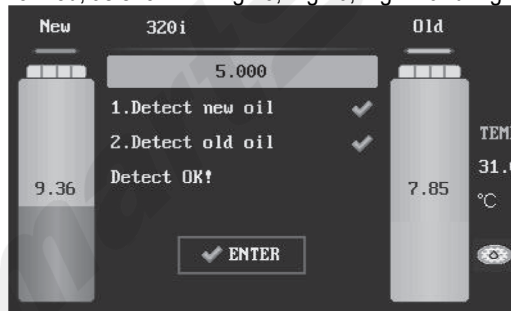

Fig.18

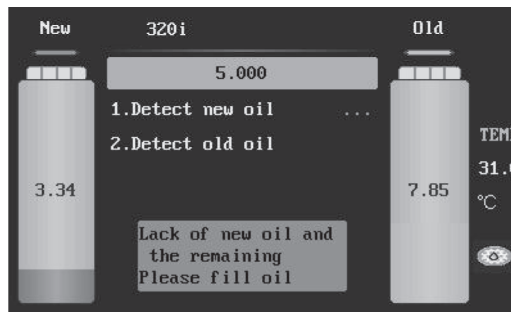

Fig.19

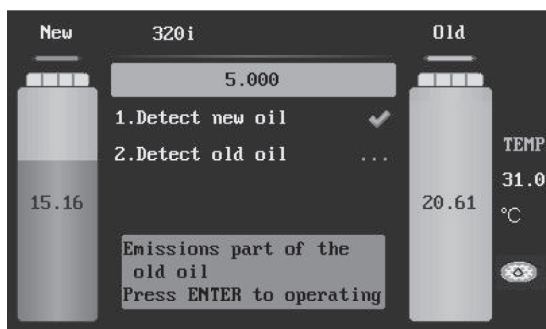

Fig.20

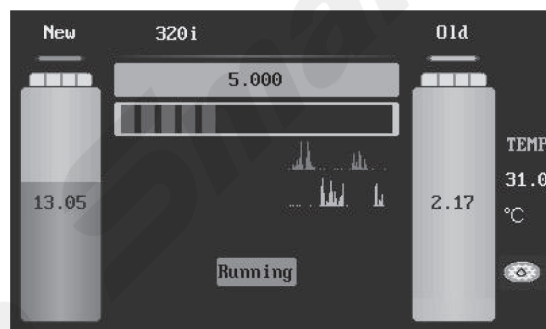

Fig.24

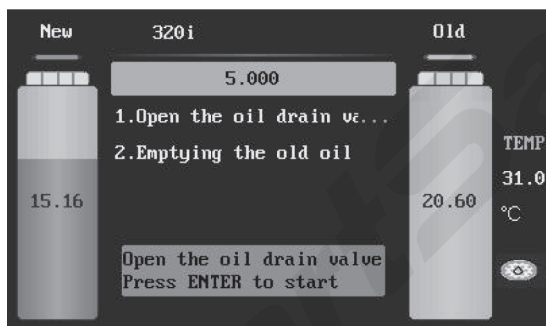

Fig.21

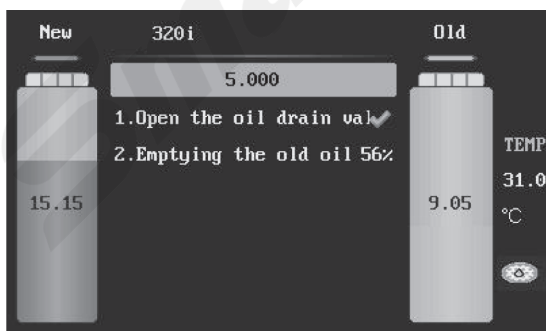

Fig.22

The system starts to drain the used fluid. You can wait for finish, as well as you can press RETURN key to stop the operation and return to the previous menu. As shown in Fig.23

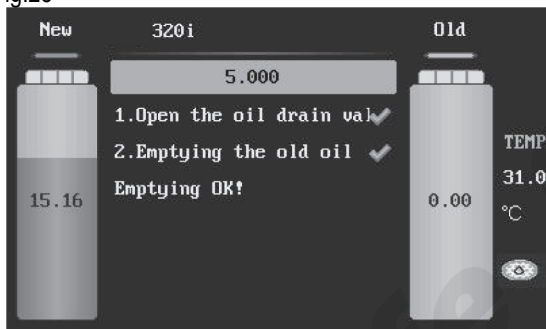

Fig.23

The interface prompts: Emptying OK! After the testing is passed, please press ENTER key to perform ATF Change while displaying progress bar and the waveforms for the change of new/used fluid. As shown in Fig.24.

After ATF Change finished, the screen will display the amount of the new fluid changed, the amount of the used fluid changed, and the error between them, while printing out the amount of the new fluid which has been changed. Press RETURN key to return to the previous menu.

- 1) Check the fluid level inside transmission. If the level is not enough, supplying fluid is required. Refer to the section of Adjust fluid level for the detailed operation.
- 2) Disconnect the unit and resume the hoses of the transmission.
- 3) Start the engine and check if there is oil leakage in the on-vehicle pipelines.

Note:

- Switch each gear when exchanging. The time of each shift should stay about half minute, which depends on actual situation, the ATF inside fluid control pipeline can be exchanged.
- To ensure the exchange quality, the quantity of new fluid inside the unit should be 2L~3L more than that of the fluid required by automatic transmission.
- Do not add new fluid from the new tank during the running period of exchange. Otherwise, the operation will result in inequality amount. If there must be added the new fluid, fill after this exchange process is completed!

5. Adjusting fluid level

5.1 Increase fluid amount

When the fluid in transmission is not enough, supply it with the desired amount of fluid. Select this operation.

- 1) Enter the menu of Adjust fluid level, select "Filling", it indicates that the fluid is being filled into the transmission. The maximum of the adjustment is the fluid amount inside new tank. The interface is as shown in Fig.25.

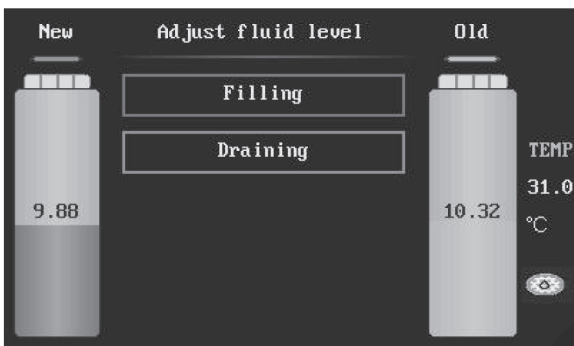

Fig.25

- 2) Input the amount to be filled, press ENTER key. As shown in Fig.26

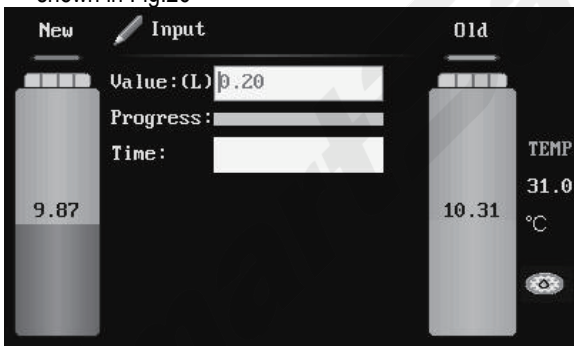

Fig.26

- 3) When the recharging is completed, the system will automatically pop up print menu. Press ENTER key select print, press RETURN key to cancel printing. Refer to Fig.27



Fig.27

5.2 Decrease fluid amount

If the quantity of the ATF is more than the standard amount, it is necessary to decrease the fluid amount inside transmission (Lower the fluid level).

- 1) Enter the menu of Adjust fluid level, select 'Draining', it indicates that the fluid inside transmission is being drained, as shown in Fig.25.
- 2) Input the amount to be drained, press ENTER key, and then start the engine, the unit will drain the set quantity of ATF to used fluid tank.
- 3) After the adjustment is completed and the unit will prompt to finish. The system will automatically return to the main menu.

6. Empty new fluid tank

- 5) Be sure that the two hoses marked with "TO TRANSMISSION" are not connected with the vehicle to be maintained.
- 6) Open the handle valve on the fluid hose marked with "EMPTY", and then place the hose into container.
- 7) The system will enter into the interface for Empty new tank, and automatically start fluid draining operation, as shown in Fig.28.

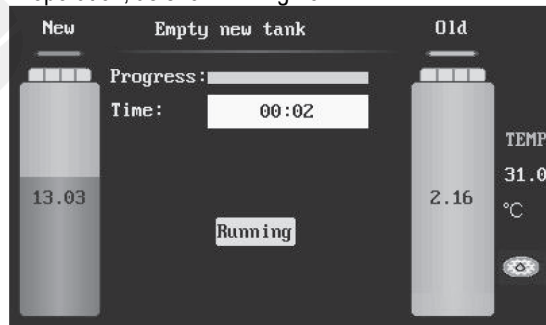

Fig.28

- 8) The unit will drain fluid until the hose marked with "Empty" has no oil draining or press RETURN key to stop draining operation.

7. Empty used fluid tank

- 1) Be sure that the two hoses marked with "TO TRANSMISSION" are not connected with the vehicle to be maintained.
- 2) Open the handle valve on the fluid hose marked with "EMPTY", and then place the hose into container.
- 3) The system will enter into the interface for Empty used tank, and automatically start fluid draining operation.
- 4) The unit will drain fluid until the hose marked with "Empty" has no oil draining or press RETURN key to stop draining operation.

8. System setting

- 1) Select system setting item in main menu, press ENTER key.
- 2) In the sub-item of system setting, select the desired setting item. The interface is as shown in Fig.29(a) and Fig.29(b).

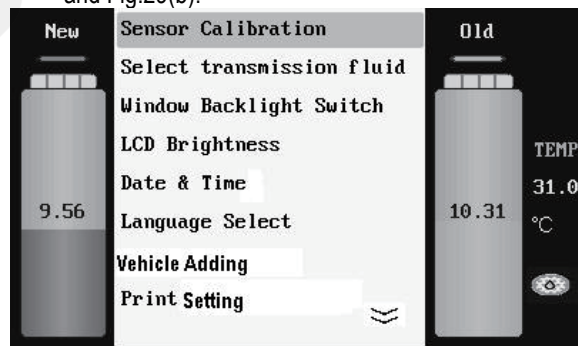

Fig.29(a)

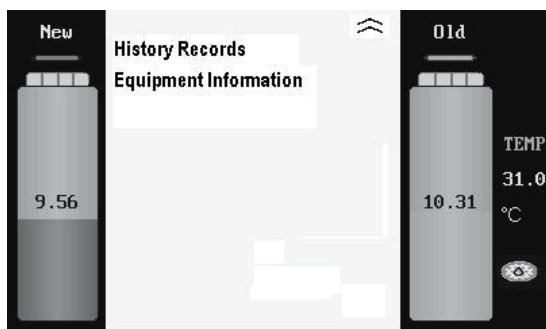

Fig.29(b)

8.1 Sensor calibration

- 1) Select the item for sensor calibration, press ENTER key to enter the sensor calibration menu as shown in Fig.30.

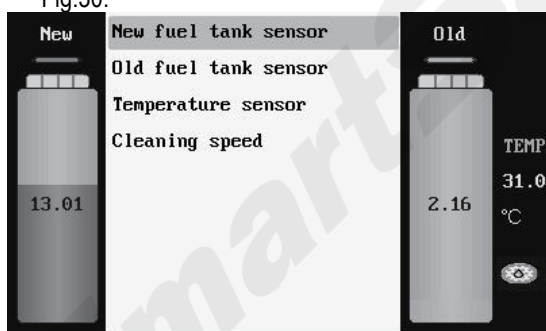

Fig.30

- 2) Press ENTER key to select the item for new fluid tank calibration, the interface is as shown in Fig. 31.

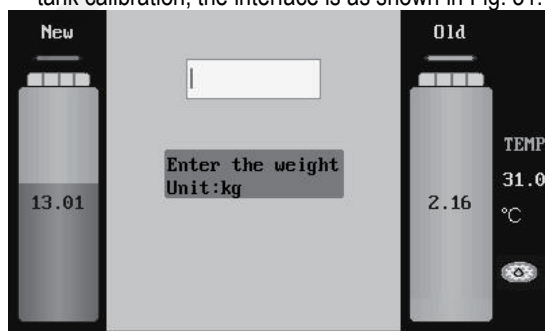

Fig. 31

- 3) According to the prompts on the interface, enter the weight value of the weight, and then press ENTER key. The interface is as shown in Fig.32.

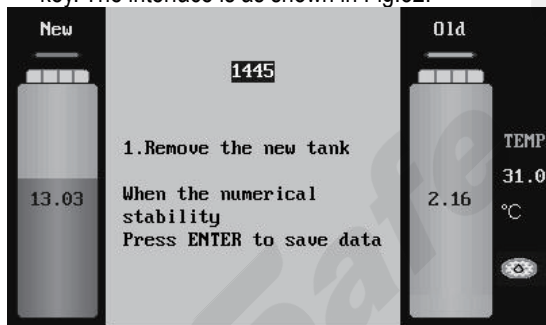

Fig.32

- 4) Remove the new fluid tank. When the value displayed on the interface is stable, please press ENTER key to save the data. The interface is as shown in Fig.33.

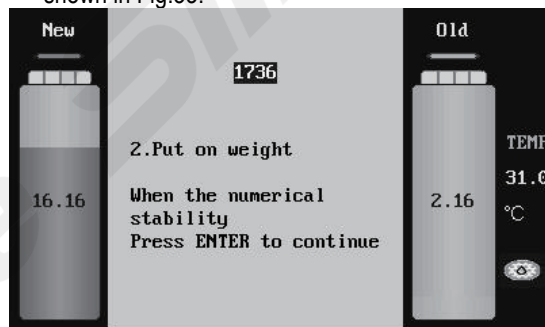

Fig.33

- 5) Put the weight on the plate. When the value displayed on the interface is stable, please press ENTER key to continue. The interface is as shown in Fig.34.

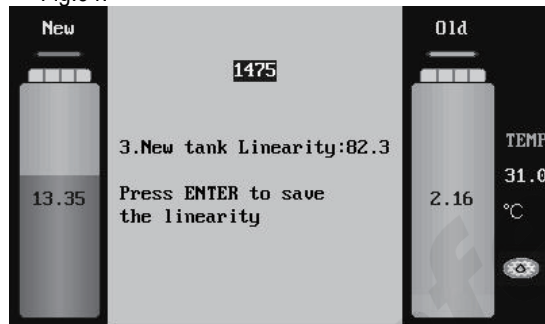

Fig.34

- 6) When the value displayed on the interface is stable, please press ENTER key again to save the data. The interface is as shown in Fig.35.

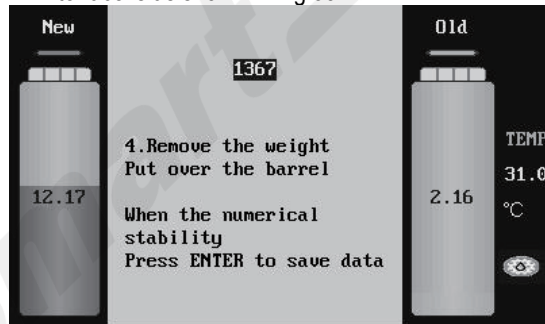

Fig.35

- 7) Remove the weight, and then place the empty new fluid tank on the plate. When the value displayed on the interface is stable, please press ENTER key to save the data. The sensor calibration for new fluid tank is completed. When filling the new fluid into new tank, the display screen will display the quantity of the fluid.

The calibration way for used fluid tank is the same as that of the new fluid tank.

- 8) Select "Temperature Sensor" calibration item in Main Menu of [Sensor Calibration], and then press ENTER key to enter, the interface is as shown in Fig.36.

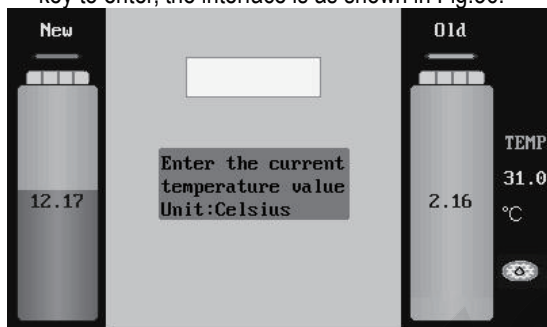

Fig.36

- 9) According to the prompts on the interface, enter the current temperature value (Unit: °C), and then press ENTER key to save the data. The interface is as shown in Fig.37.

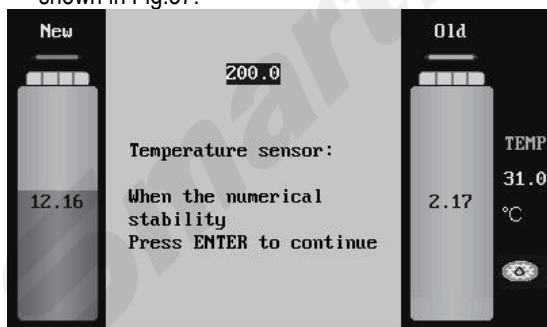

Fig.37

- 10) When the value is stable, press ENTER key again to finish the temperature sensor calibration.

- 11) Select "Cleaning Speed" option in the Main Menu of [Sensor Calibration], and then press ENTER key to enter the interface as shown in Fig.38.

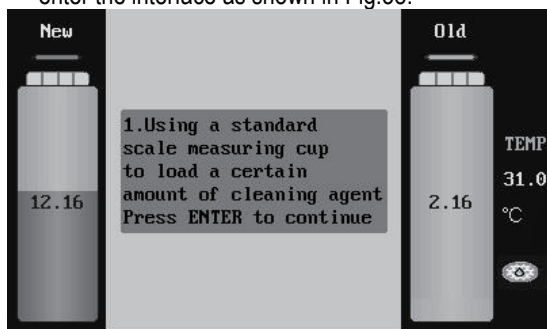

Fig.38

- 12) According to the prompts on the interface, load a certain amount of detergent to a standard measuring cup, and then press ENTER key to continue. The interface is as shown in Fig.39.

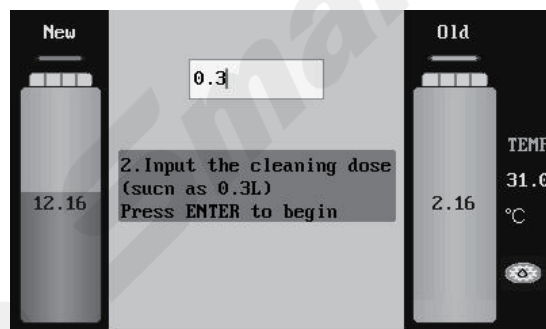

Fig.39

- 13) According to the prompts on the interface, enter the amount (such as 0.3L) of detergent to be added into the system, and then press ENTER key to start adding. The interface is as shown in Fig.40.

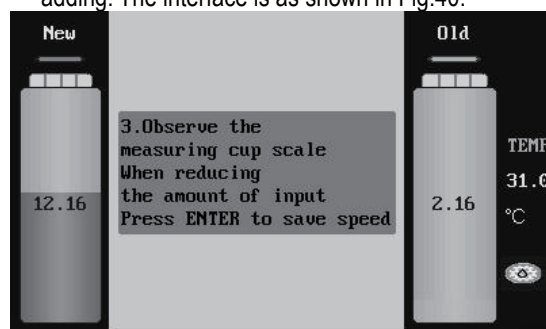

Fig.40

- 14) Observe the measuring cup's scale change status, press ENTER key to save the speed value when the detergent amount in the standard measuring cup is decreased by 0.3L. The Cleaning Speed calibration is finished.

8.2 Select transmission fluid

This function can choose the type of transmission fluid. There are four types and a kind of other types, if you don't clear transmission fluid species, can choose other. As shown in Fig.41.

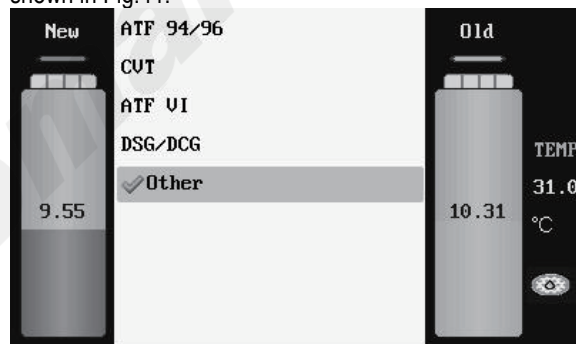

Fig.41

8.3 Window Light Switch Setting

Select Window Backlight Switch and press ENTER key to enter the setting interface as shown in Fig.42. Press ENTER key to select on or off.

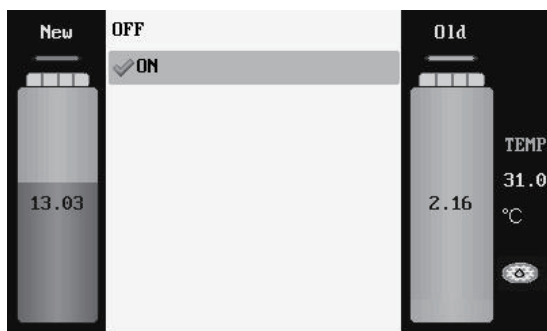

Fig.42

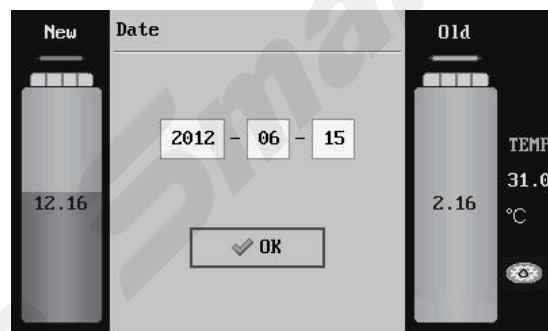

Fig.45

8.4 LCD Screen Brightness Adjustment

Select LCD Screen Brightness and press ENTER key to enter the setting interface as shown in Fig.43. Press [UP]/[DOWN] key to select the desired brightness, and press RETURN key to confirm and return.



Fig.43

According to the prompts on the interface, enter the date (4 bits for year, 2 bits for month and other 2 bits for date), and then press ENTER key to confirm. The interface prompts "OK".

- b) Set Time
On the menu of [Date & Time], please select [Set Time] option, and then press ENTER to confirm, the interface is as shown in Fig.46.



Fig.46

8.5 Date & Time

Select [Date & Time] option on the Main Menu of [System Setting] and then press ENTER key to enter the interface as shown in Fig.44.

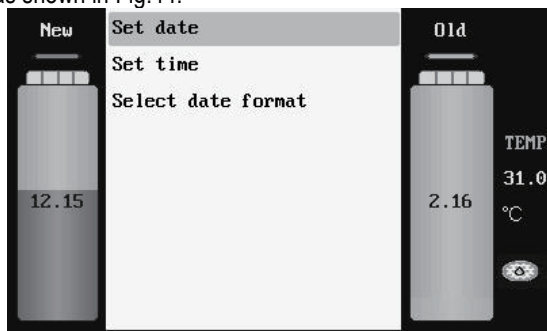

Fig.44

According to the prompts on the interface, enter the time (2 bits for hour and other 2 bits for minute), and then press ENTER key to confirm. The interface prompts "OK".

- c) Select Date Format
On the menu of [Date & Time], please select [Set Date Format] option, and then press ENTER to confirm, the interface is as shown in Fig.47.



Fig.47

- a) Set Date
On the menu of [Date & Time], please select [Set Date] option, and then press ENTER to confirm, the interface is as shown in Fig.45.

Select the desired date format, and then press ENTER key to confirm.

8.6 Language setting

Select the language setting and press ENTER key to enter the setting interface as shown in Fig.48(a) and Fig.48(b). Press [UP]/[DOWN] key to select the desired language, and then press ENTER key to confirm and return.



Fig.48(a)



Fig.48(b)

8.7 Vehicle Adding

Select [Vehicle Adding] setting option on the Main Menu of [System Setting], and then press ENTER key to enter the interface as shown in Fig.49.

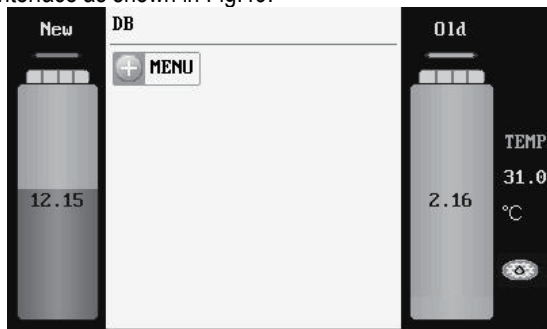

Fig.49

Select [MENU] option, and then press ENTER key to enter the interface as shown in Fig.50. Press the LIGHT key can switch between uppercase and lowercase letters.



Fig.50

According to prompts on the interface, add the menu (such as BMW). The interface is as shown in Fig.51.

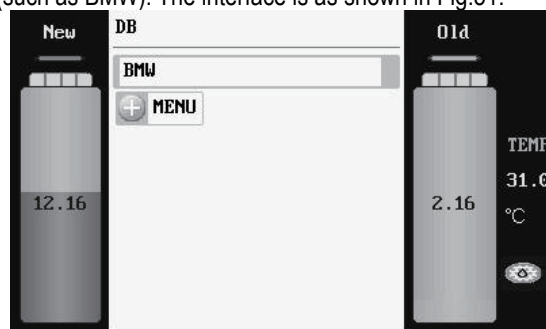

Fig.51

Press ENTER key to enter the menu of BMW. The interface is as shown in Fig.52.



Fig.52

Select [BOTTOM NODE] option can add the last layer menu, and then press ENTER key to confirm. The interface is as shown in Fig.53.



Fig.53

Enter the fluid amount (such as 12.000, unit: L) to be changed, and then press ENTER key to confirm

performing. Press RETURN key to return.

Select the menu option to be deleted, and then press DEL key. The interface is as shown in Fig.54.

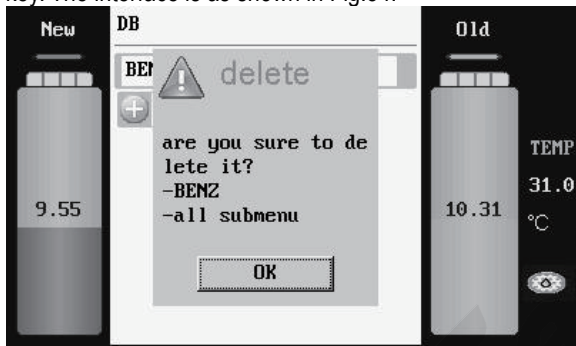

Fig.54

Press ENTER key executive delete function. Press RETURN key to return to the previous menu directly.

8.8 Print Setting

Select Print Setting option, the system will enter the interface as shown in Fig.55.

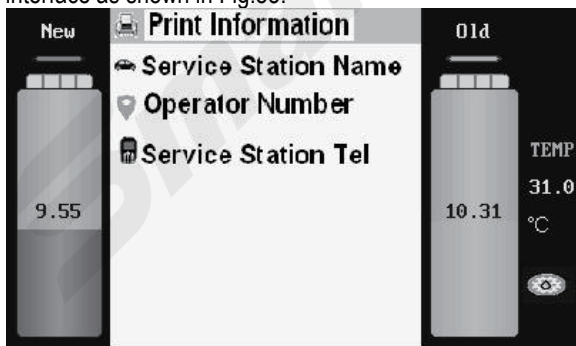

Fig.55

Print information can choose print output content. The information contained in the options that are not selected cannot be printed out, as shown in Fig.56.

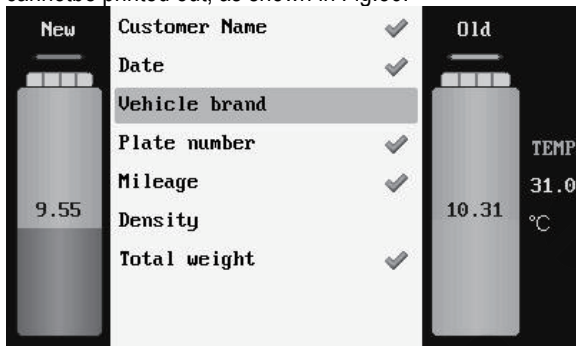

Fig.56

8.9 History Records

The History Records can be used to check the change amount and time of new fluid, used fluid and detergent. After the filters are exchanged with the new ones, it is required to delete the original history records, otherwise the filter status icon on the interface will not be displayed

correctly. Do not delete the original history records until the fluid filters are exchanged, otherwise it will influence your correct judgement to the status of the filters. When the added fluid change amount is more than 3600L, the system will prompt that the fluid filters are abnormal(i.e. the filter status icon on the interface will turn orange from green), as shown in Fig.57. It is suggested that the fluid filters should be replaced in this case.

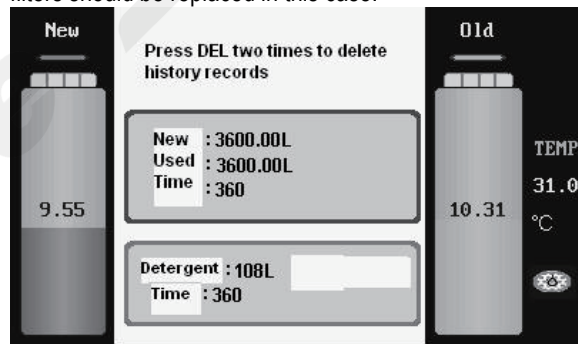

Fig.57

After replacing the fluid filters, press key DEL two times on the interface of History Records to delete the original history records, and mean while delete the prompts for abnormal fluid filters(i.e. the filter status icon on the interface will automatically turn green from orange), as shown in Fig.58.

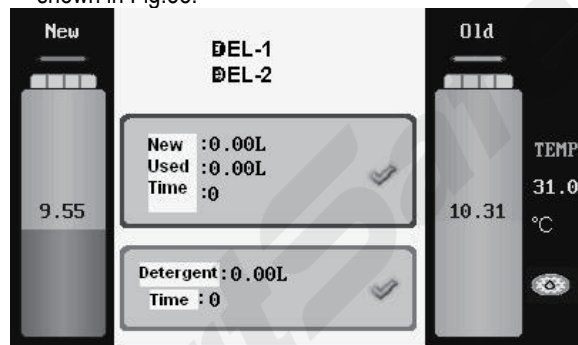

Fig.58

8.10 Device information

Select the device information option and press ENTER key. The device information is displayed as shown in Fig.59.

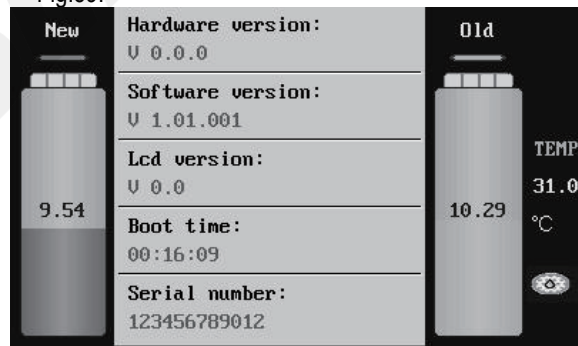

Fig.59

Warning

Warning sound: When there is no fluid in the new tank or the operation is completed, the unit enters the standby state.

Maintenance

- Pay attention to each connection to check if there is any leakage during fluid exchange. When any leak is found, stop the CAT-501S immediately and check for the unit. Start to exchange fluid again after reconnection is made.
- Before cleaning up the unit, the used fluid should be drained out from the used fluid tank and the new fluid should be drained out from new tank and stored in container after every usage to protect the electronic scale is on the no load state at non-work condition.
- Keep the new fluid tank clean.
- Please recalibrate the electronic scale after replacing the main-board and/or the electronic scale itself.

Main adapters

No.	ERP Code	Picture	Size	Applicable Car Type
A01	503240060		Φ8, Φ10, Φ5	General type (TOYOTA, MITSUBISHI SPACE WAGON GLXI) LEXUS ES300, HONDA and NISSAN car type
Φ8 Hose	503240061		Φ8	General type (TOYOTA, MITSUBISHI SPACE WAGON HONDA and NISSAN GLXI) LEXUS ES300
Φ10 Hose	503240062		Φ10	
Φ12 Hose	503240063		Φ12	
A03A	503240064		M16×1.5 (outside)	One group CADILLAC, BMW 750 AT type 4HP-22 4HP-24 A421, MITSUBISHI V6,3000
A03B	503240028		M16×1.5 (inside)	One group CADILLAC, BMW 750 AT type 4HP-22 4HP-24 A42
A05A	503240029		M18×1.5 (outside)	EUROPEAN Eg: New VECTRA, PASSAT
A05B	503240030		M18×1.5 (inside)	EUROPEAN New VECTRA, PASSAT
A06A	503240031		G1/4 (outside)	CHRYSLER GRAND VOYAGER, CHRYSLER 300
A06B	503240032		G1/4	CHRYSLER 13.157mm GRAND VOYAGER, CHRYSLER 300
A07A	503240033		M18×1.5 (outside)	EUROPEAN New VECTRA
A07B	503240034		M18×1.5 (inside)	EUROPEAN New VECTRA
A08A	503240035		UNF1/2-20 (outside)	GENERAL MOTORS LINCOLN, CADILLAC
A08B	503240036		UNF1/2-20 (inside)	GENERAL MOTORS LINCOLN, CADILLAC

A10A	503240037		UNF1/2-20 (outside)	FORD, eg: VOLVO, FORD CHRYSLER: DAIMLER-BENZ
A10B	503240038		UNF1/2-20 (inside)	FORD, eg: VOLVO, FORD CHRYSLER: DAIMLER-BENZ
A11A	503240039		Z1/4 *18 13.616	FORD LINCOLN, VOLVO
A11B	503240040		Z1/4	FORD LINCOLN, VOLVO
A12A	503240041		UNF5/8-18 (outside)	FORD
A12B	503240042		UNF5/8-18 (inside)	FORD CADILLAC
A13A	503240043		UNF5/8-18 (Outside)	GENERAL MOTORS CHRYSLER
A13B	503240044		UNF5/8-18 (Inside)	CHRYSLER GENERAL MOTORS
A14A	503240046		UNF5/8-18 (Outside)	FORD, VOLVO
A14B	503240047		UNF5/8-18 (Inside)	FORD, VOLVO
A15A	503240048		UNF5/8-18 (outside)	CHRYSLER Benxc200,s325i GENERAL MOTORS
A15B	503240049		UNF5/8-18 (inside)	CHRYSLER Benxc200,s325i GENERAL MOTORS
A16A	503240050		M18x1.5 (outside)	EUROPEAN
A16B	503240051		M18x1.5 (inside)	EUROPEAN
A17A	503240052		Φ14.85 (outside)	
A17B	503240053		Φ14.95 (inside)	EUROPEAN
A20A	503240054		UNF1/2-20 (outside)	FORD
A20B	503240055		UNF1/2-20 (inside)	FORD
A43	503240056		M12 × 1.5	
A44	503240057		M12	

Warranty

THIS WARRANTY IS EXPRESSLY LIMITED TO PERSONS WHO PURCHASE SMARTSAFE PRODUCTS FOR PURPOSES OF RESALE OR USE IN THE ORDINARY COURSE OF THE BUYER'S BUSINESS.

SMARTSAFE electronic product is warranted against defects in materials and workmanship for one year (12 months) from date of delivery to the user. This warranty does not cover any part that has been abused, altered, used for a purpose other than for which it was intended, or used in a manner inconsistent with instructions regarding use. The exclusive remedy for any automotive meter found to be defective is repair or replacement, and SMARTSAFE shall not be liable for any consequential or incidental damages. Final determination of defects shall be made by SMARTSAFE in accordance with procedures established by SMARTSAFE. No agent, employee, or representative of SMARTSAFE has any authority to bind SMARTSAFE to any affirmation, representation, or warranty concerning SMARTSAFE automotive meters, except as stated herein.

Disclaimer

THE ABOVE WARRANTY IS IN LIEU OF ANY OTHER WARRANTY, EXPRESSED OR IMPLIED, INCLUDING ANY WARRANTY OF MERCHANTABILITY OR FITNESS FOR A PARTICULAR PURPOSE.

Order Information

Replaceable parts can be ordered directly from your SMARTSAFE authorized tool supplier. Your order should include the following information:

Quantity
Part number
Item description

Customer Service

If you have any questions on the operation of the unit, please contact us:
Tel: +86-0755-89589810

If your unit requires repair service, return it to the manufacturer with a copy of the sales receipt and a note describing the problem. If the unit is determined to be in warranty, it will be repaired or replaced at no charge. If the unit is determined to be out of warranty, it will be repaired for a nominal service charge. Send the unit pre-paid to:

Attn: Overseas Department
3F, Building B, Qiao'an Technology Industrial Park, Guanlan, Longhua New District,
Shenzhen, Guangdong,
P. R. China, 518109